



**Wireless MPEG4/MJPEG  
Network Camera  
ALL2281**

**Advanced Installation Guide**

Version 1.0

# PREFACE

---

Thank you for purchasing the ALL2281 Wireless MPEG4/MJPEG Network Camera, a powerful dual-codec wireless network camera with the 1-way or 2-way audio function that provides the high-quality image and on-the-spot audio via the Internet connection. The Infrared LEDs and light sensor (optional) enable the camera to capture images even in the dark environment. The camera can be installed as a standalone system within your application environment easily and quickly, and supports remote management function so that you can access and control it using a Web browser on your PC.

This *Advanced Installation Guide* provides you with the instructions and illustrations on how to use your camera, which includes:

- Chapter 1 Introduction to Your Camera** describes the features of the camera. You will also know the components and functions of the camera.
- Chapter 2 Hardware Installation** helps you install the camera according to your application environment. You can use this camera at home, at work, at any where you want.
- Chapter 3 Accessing the Camera** lets you start using your camera without problem. The camera can be set up easily and work within your network environment instantly.
- Chapter 4 Configuring the Camera** guides you through the configuration of the camera using the web browser on your PC.
- Chapter 5 Appendix** provides the specification of the camera and some useful information for using your camera.

**NOTE** The illustrations and configuration values in this guide are for reference only. The actual settings depend on your practical application of the camera.

# Contents

PREFACE .....	1
CHAPTER 1 .....	3
INTRODUCTION TO YOUR CAMERA.....	3
1.1 CHECKING THE PACKAGE CONTENTS .....	3
1.2 GETTING TO KNOW YOUR CAMERA.....	4
1.3 FEATURES AND BENEFITS .....	6
1.4 SYSTEM REQUIREMENT .....	8
CHAPTER 2.....	9
HARDWARE INSTALLATION.....	9
2.1 INSTALLING THE CAMERA STAND .....	9
2.2 CONNECTING THE CAMERA TO LAN/WLAN .....	10
2.3 APPLICATIONS OF THE CAMERA .....	11
CHAPTER 3.....	12
ACCESSING THE CAMERA .....	12
3.1 USING IP FINDER.....	12
3.2 ACCESSING TO THE CAMERA.....	13
3.3 CONFIGURING THE IP ADDRESS OF THE PC.....	16
CHAPTER 4.....	17
CONFIGURING THE CAMERA .....	17
4.1 USING THE WEB CONFIGURATION.....	17
4.2 USING SMART WIZARD .....	18
4.3 BASIC SETUP.....	21
4.4 NETWORK SETTINGS .....	23
4.5 SETTING UP VIDEO & AUDIO.....	29
4.6 EVENT SERVER CONFIGURATION.....	33
4.7 MOTION DETECT.....	36
4.8 EVENT CONFIG.....	37
4.9 TOOLS .....	40
4.10 USB.....	42
4.11 INFORMATION .....	44
CHAPTER 5.....	45
APPENDIX .....	45
A.1 SPECIFICATION .....	45
A.2 GLOSSARY OF TERMS .....	47

# CHAPTER 1

---

## INTRODUCTION TO YOUR CAMERA

### 1.1 Checking the Package Contents

Check the items contained in the package carefully. You should have the following:

- One ALL2281 Wireless MPEG4/MJPEG Network Camera.
- One AC Power Adapter.
- One External Antenna.
- One Camera Stand.
- One Ethernet Cable (RJ-45 type).
- One Installation CD-ROM.
- One *Quick Installation Guide*.

**NOTE** Once any item contained is damaged or missing, contact the authorized dealer of your locale.

## 1.2 Getting to Know Your Camera

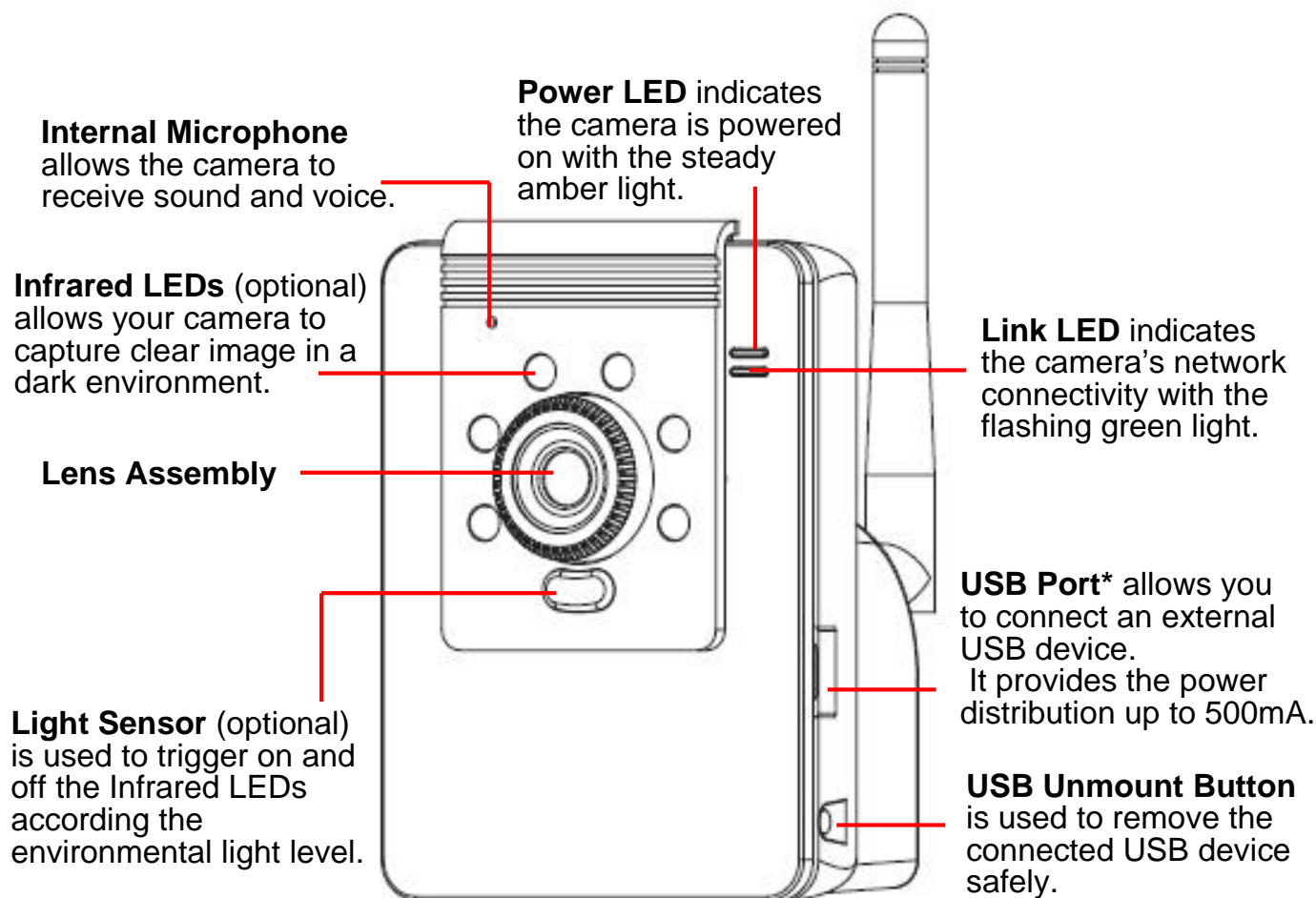

**Front View**

\* The camera's USB port supports WCN (Windows Connect Now) technology, which allows you to use the notebook computer to set up and store your wireless networking configuration on the USB storage device, and then retrieve the wireless settings when you connect the USB storage device to the camera.

**NOTE** After long pressing the Unmount button for four seconds, the Power LED starts flashing. When the Power LED resumes the steady amber light, you can remove the USB device safely.

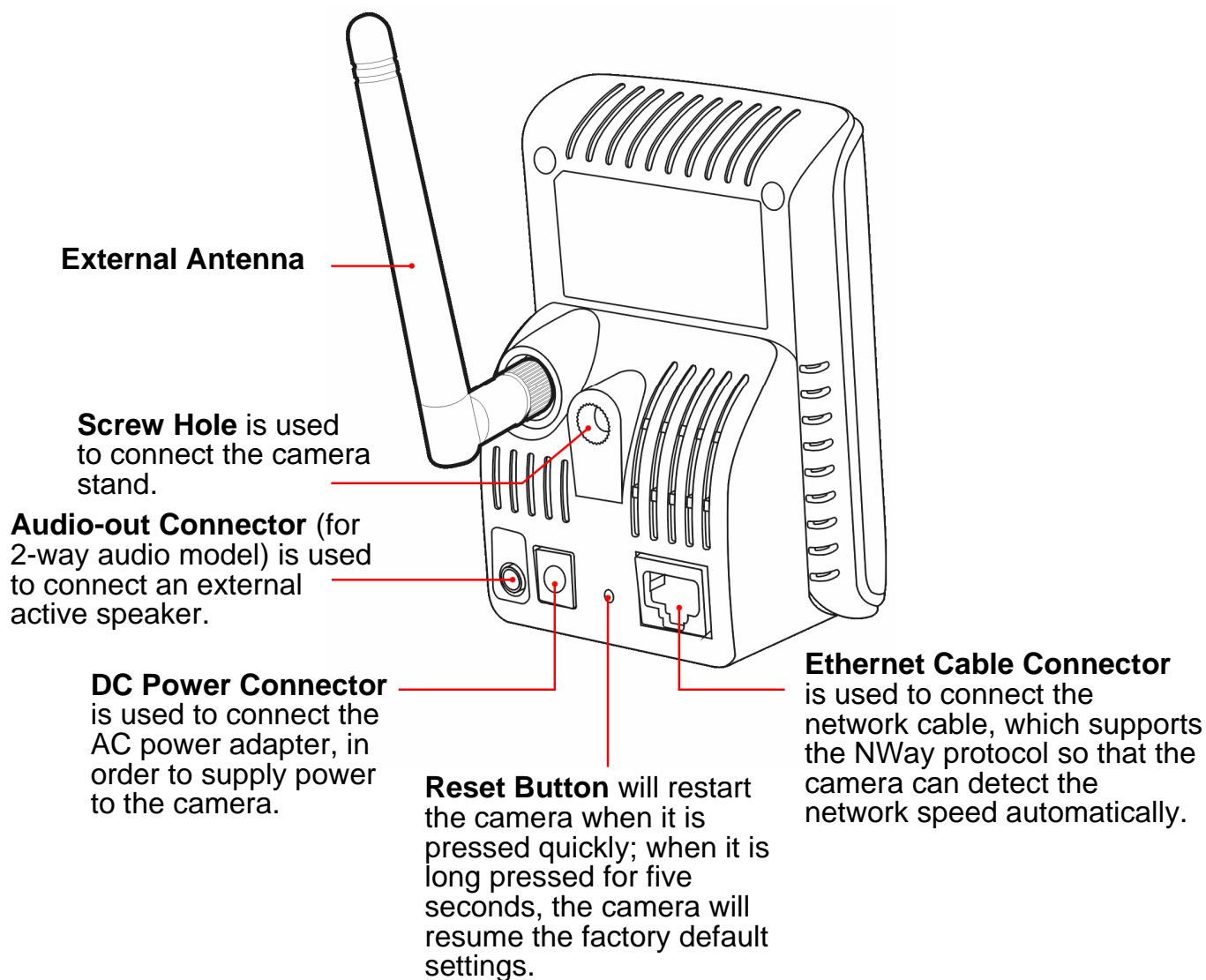

## Rear View

## 1.3 Features and Benefits

### ■ **MPEG4/MJPEG Dual-codec Supported**

The camera provides you with excellent images by the MPEG4/MJPEG dual-codec selectable technology, allowing you to adjust image size and quality, and bit rate according to the networking environment.

### ■ **1-way/2-way Audio Capability**

The built-in microphone of the camera provides on-the-spot audio via the Internet, allowing you to monitor the on-site voice. In addition, you can connect an external speaker to the camera to speak through the camera (for 2-way audio model only); the camera is embedded with an echo cancellation processor to provide a better sound quality.

### ■ **Day & Night Surveillance Supported (optional)**

The six Infrared LEDs around the standard lens assembly (optional) enable the camera to capture crystal clear images in the dark environment or at night. When the Light Sensor detects the environmental light level becomes low, the camera captures the images in black & white mode using these infrared LEDs.

### ■ **Supports Multiple Profiles**

The camera supports multiple profiles simultaneously, so that you can separately set up different image settings (such as image quality and frame rate) for the three video types of the camera: MPEG4, MJPEG, and 3GPP.

### ■ **Supports RTSP**

The camera supports RTSP (Real Time Streaming Protocol), which is a technology that allows you to view streaming media via the network. You can view the real-time video with the Quick Time player or RealPlayer. To view the real-time streaming image on your computer, open the Web browser and enter the RTSP link: [rtsp://\(IP address of the camera\)/mpeg4](rtsp://(IP address of the camera)/mpeg4).

## ■ **Remote Control Supported**

By using a standard Web browser or the bundled Ultra View software application, the administrator can easily change the configuration of the camera via Intranet or Internet. In addition, the camera can be upgraded remotely when a new firmware is available. The users are also allowed to monitor the image and take snapshots via the network.

## ■ **Supports Connection to the External Devices**

With the auxiliary Input/Output connectors, you can connect the camera to a variety of external devices, such as the external speaker and the USB device.

## ■ **Multiple Platforms Supported**

The camera supports multiple network protocols, including TCP/IP, SMTP e-mail, HTTP, and other Internet related protocols. Therefore, you can use the camera in a mixed operating system environment, such as Windows 2000 and Windows XP.

## ■ **Multiple Applications Supported**

Through the remote access technology, you can use the cameras to monitor various objects and places for your own purposes.

For example, babies at home, patients in the hospital, offices and banks, and more. The camera can capture both still images and video clips, so that you can keep the archives and restore them at any time.



## 1.4 System Requirement

### ■ Networking

LAN: 10Base-T Ethernet or 100Base-TX Fast Ethernet.

WLAN: IEEE 802.11b/g.

### ■ Accessing the Camera using Web Browser

Platform: Microsoft® Windows® 2000/XP/Vista

CPU: Intel Pentium III 350MHz or above

RAM: 128MB

Resolution: 800x600 or above

User Interface: Microsoft® Internet Explorer 6.0 or above

Apple Safari 2 or above

Mozilla Firefox 2.00 or above

### ■ Accessing the Camera using Ultra View

Platform: Microsoft® Windows® 2000/XP/Vista

Hardware Requirement:

1 camera connected: Intel Pentium III 800MHz; 512MB RAM

2 ~ 4 cameras connected: Intel Pentium 4 1.3GHz; 512MB RAM

5 ~ 8 cameras connected: Intel Pentium 4 2.4GHz; 1GB RAM

9 ~ 16 cameras connected: Intel Pentium 4 3.4GHz; 2GB RAM

Resolution: 1024x768 or above

**NOTE** If you connect multiple cameras to monitor various places simultaneously, you are recommended to use a computer with higher performance.

# CHAPTER 2

---

## HARDWARE INSTALLATION

### 2.1 Installing the Camera Stand

The camera comes with a camera stand, which uses a swivel ball screw head to lock to the camera's screw hole. When the camera stand is attached, you can place the camera anywhere by mounting the camera through the three screw holes located in the base of the camera stand.

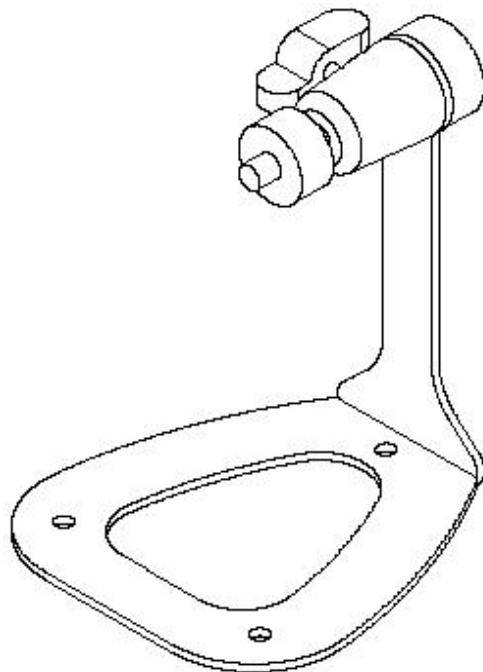

**The Camera Stand**

## 2.2 Connecting the Camera to LAN/WLAN

Use the provided Ethernet cable to connect the camera to your local area network (LAN).

When you connect the AC power adapter, the camera is powered on automatically. You can verify the power status from the Power LED on the front panel of the camera.

Once connected, the Link LED starts flashing green light and the camera is on standby and ready for use now.

Connecting the Ethernet Cable

If you use a wireless network in your application environment, you need to attach the included external antenna to the camera.

When the camera is powered on, the camera will automatically search any access point with “default” SSID.

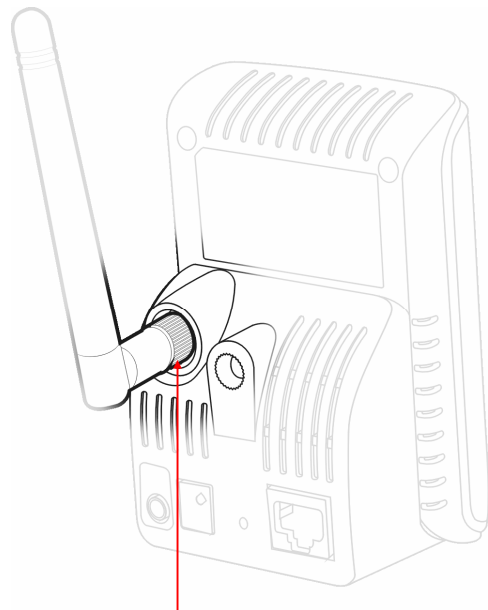
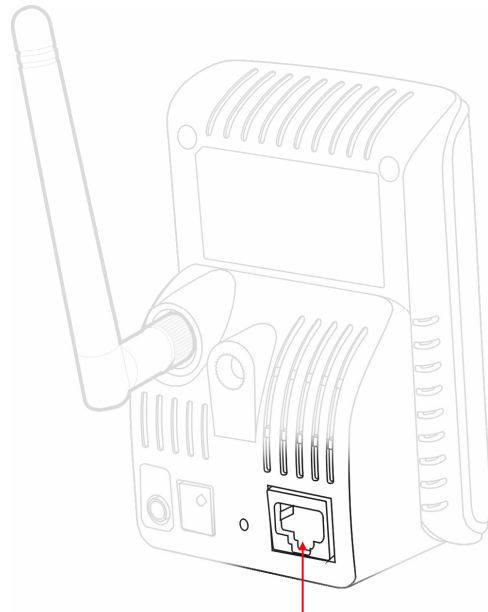

Connecting the External Antenna

**NOTE** If the camera cannot to your wireless network, you need to install the camera in LAN and proceed with WLAN settings.

## 2.3 Applications of the Camera

The camera can be applied in multiple applications, including:

- Monitor local and remote places and objects via Internet or Intranet.
- Capture still images and video clips remotely.
- Upload images or send email messages with the still images attached.

The following diagram explains one of the typical applications for your camera and provides a basic example for installing the camera.

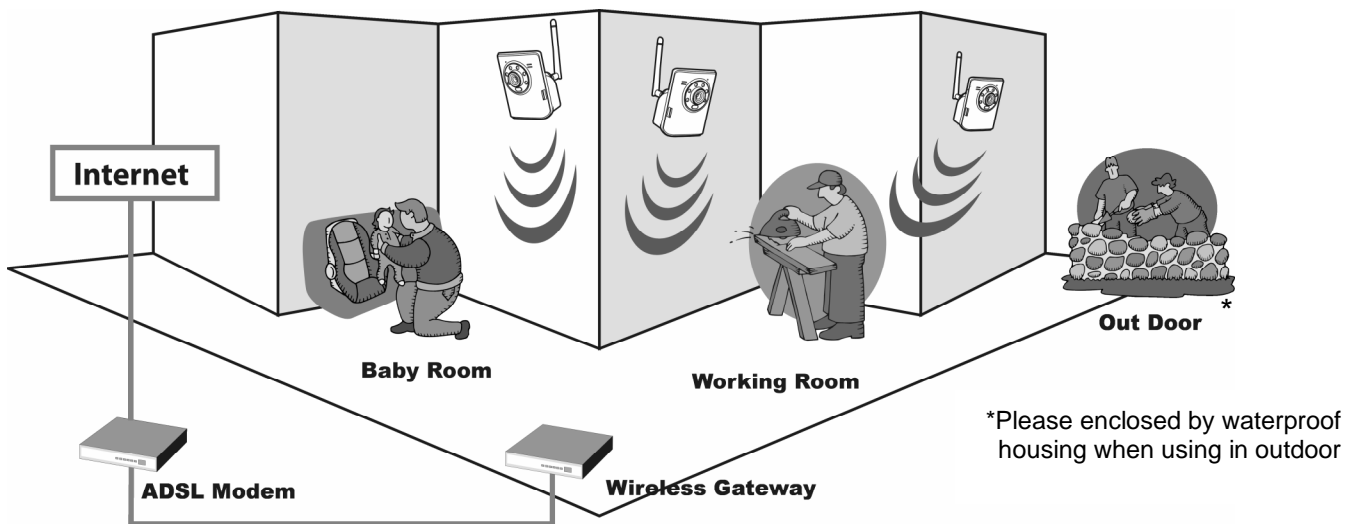

### Home Applications

# CHAPTER 3

---

## ACCESSING THE CAMERA

### 3.1 Using IP Finder

The camera comes with a conveniently utility, IP Finder, which is included in the Installation CD-ROM, allowing you to search the camera on your network easily.

1. Insert the Installation CD-ROM into your computer's CD-ROM drive to initiate the Auto-Run program.
2. Click the **IP Finder** item to launch the utility. The control panel will appear as below.

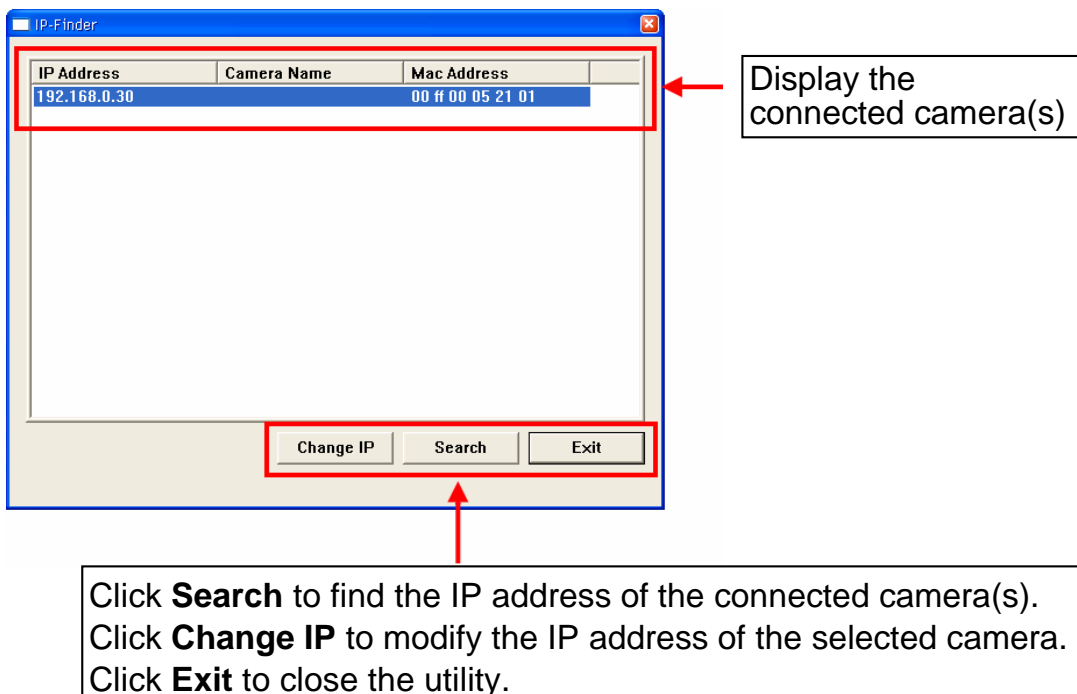

3. Once you get the IP address of the camera, launch the Web browser or Ultra View to access your camera.

## 3.2 Accessing to the Camera

Whenever you want to access the camera:

1. Open the Web browser on your computer (for example, Microsoft Internet Explorer in this guide)
2. Type the default IP address (**192.168.0.30**) or the IP address found by IP Finder in the Address bar, and then press [Enter].
3. When the login window appears, enter the default User name (**admin**) and password (**admin**) and press **OK** to access to the main screen of the camera's Web Configuration.

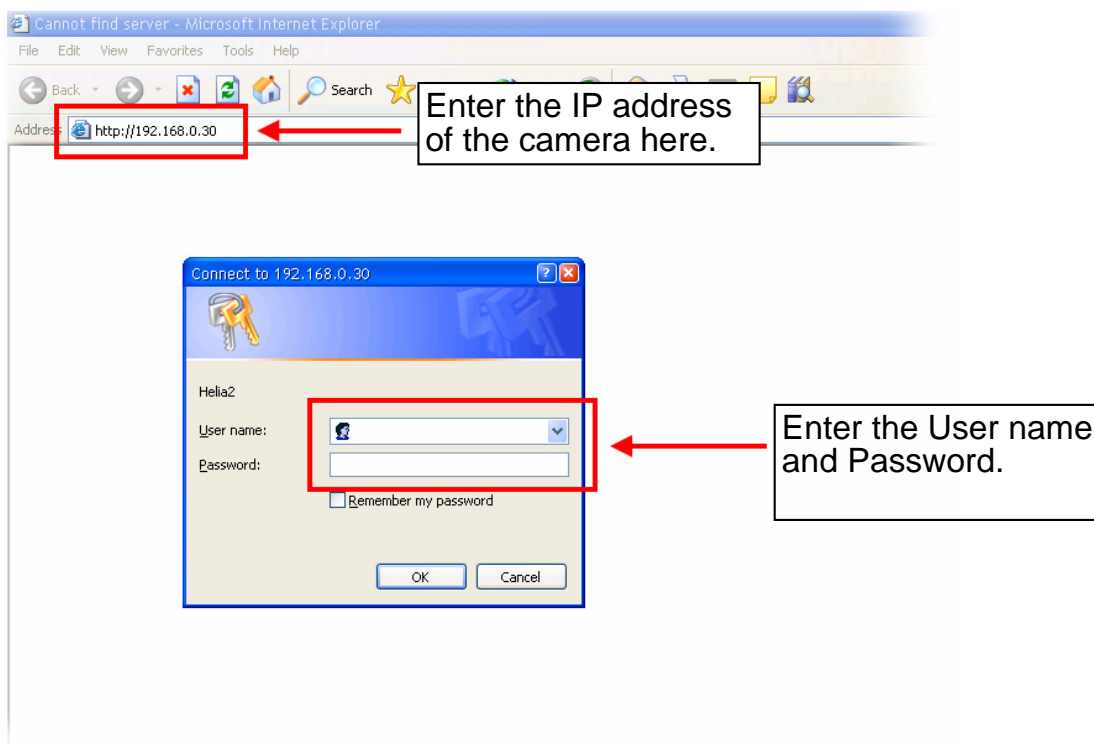

**NOTE** If you are initially access to the camera, you will be ask to install a new plug-in for the camera. Permission request depends on the Internet security settings of your computer. Click **Yes** to proceed.

After you login into the Web Configuration of the camera, the main page will appear as below:

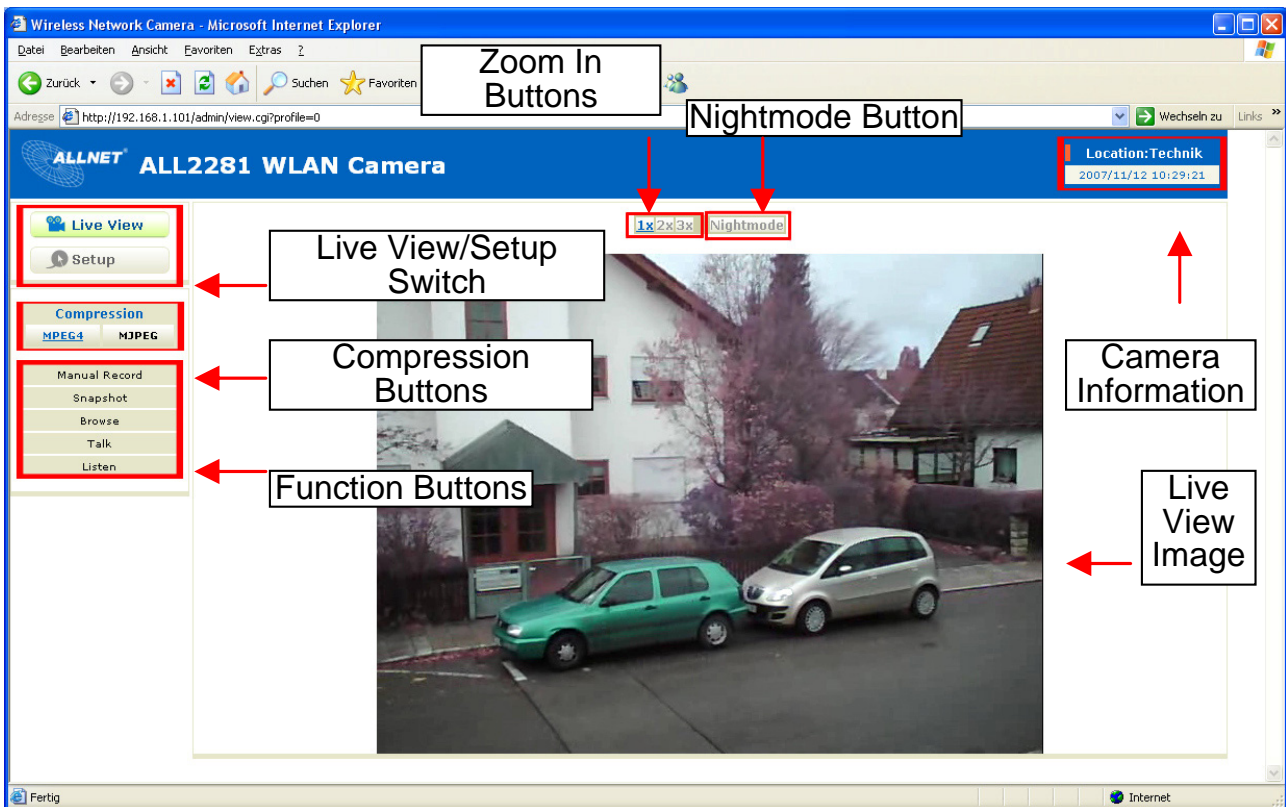

The main page of the Web Configuration provides you with many useful information and functions, including:

- **Camera Information** – Display the camera’s location and the current date & time. The information can be modified in the Web Configuration.
- **Live View Image** – Displays the real-time image of the connected camera.
- **Live View/Setup Switch** – Click **Setup** to configure the camera. For details, see Chapter 4.
- **Compression Buttons** – Select to transmit and record the video using MPEG4 or MJPEG compression.

- **Function Buttons** – Use these buttons to control the audio and video functions.
  - **Manual Record** allows you to record and save a video clip.
  - **Snapshot** allows you to capture and save a still image.
  - **Browse** allows assign the destination folder to store the video clips and still images.
  - **Talk** allows you to speak out through the camera. Please note that this button displays only for the 2-way audio model, and only one user is allowed to use this function at a time.
  - **Listen** allows you receive the on-site sound and voice from the camera.
- **Zoom In Buttons** – Click the buttons to zoom in the live view image by 1x, 2x, and 3x.
- **Nightmode Button** – Click the button to enable the “nightshot mode” to deliver clearer images in the dark environment. However, this will reduce the frame rate of video setting.



### 3.3 Configuring the IP Address of the PC

If you are failed to access to the camera, please check the IP address of your computer. When you connect the camera to your computer directly to proceed with configuration of the camera, you need to set up the IP addresses to be in the same segment for the two devices to communicate.

1. On your computer, click **Start > Control Panel** to open the Control Panel window.
2. Double-click **Network Connection** to open the Network Connection window.
3. Right-click **Local Area Connection** and then click **Properties** from the shortcut menu.
4. When the Local Area Connection Properties window appears, select the **General** tab.
5. Select **Internet Protocol [TCP/IP]** and then click **Properties** to bring up the Internet Protocol [TCP/IP] Properties window.
6. To configure a fixed IP address that is within the segment of the camera, select the **Use the following IP address** option. Then, enter an IP address into the empty field. The suggested IP address is **192.168.0.x** (x is 0~254 except 30), and the suggested Subnet mask is **255.255.255.0**.
7. When you are finished, click **OK**.

# CHAPTER 4

## CONFIGURING THE CAMERA

### 4.1 Using the Web Configuration

You can access and manage the camera through the Web browser and the provided software application Ultra View. This chapter describes the Web Configuration, and guides you through the configuration of the camera by using the web browser.

To configure the camera, click **Setup** on the main page of Web Configuration. The Web Configuration will start from the **Basic** page.

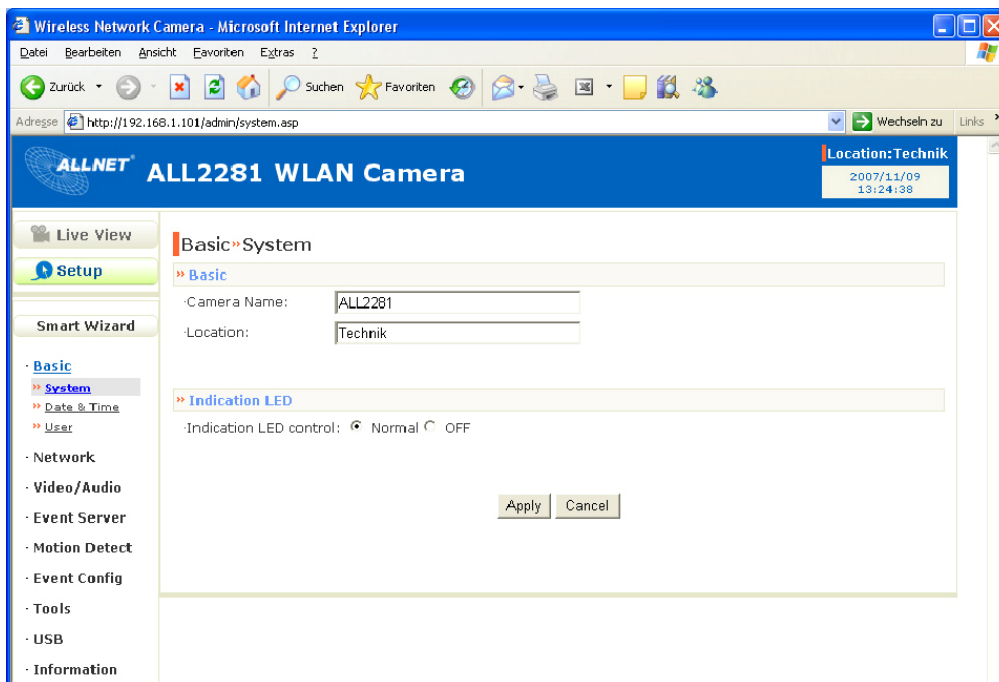

The Web Configuration contains the settings that are required for the camera in the left menu bar, including **Smart Wizard**, **Basic**, **Network**, **Video/Audio**, **Event Server**, **Motion detect**, **Event Config**, **Tools**, **USB**, and **Information**.

## 4.2 Using Smart Wizard

The camera's Smart Wizard lets you configure your camera easily and quickly. The wizard will guide you through the necessary settings with detailed instructions on each step.

To start the wizard, click **Smart Wizard** in the left menu bar.

### Step 1. Camera Settings

#### Camera Setting

· Camera Name:

· Location:

· Admin Password:

· Confirm Password:

Enter the name for the camera and place.

Enter the administrator password.

### Step 2. IP Settings

#### IP Settings

DHCP

Static IP

· IP:  .  .  .

· Subnet Mask:  .  .  .

· Default Gateway:  .  .  .

· Primary DNS:  .  .  .

· Secondary DNS:  .  .  .

PPPoE

· User Name:

· Password:

Select the IP setting according to your network: **DHCP, Static IP,**

### Step 3. Email Settings

**Email Settings**

•SMTP Server Address:

•Sender Email Address:

•Authentication Mode:  None  SMTP

•Sender User Name:

•Sender Password:

•Receiver #1 Email Address:

•Receiver #2 Email Address:

Enter the required information to be able to send email with image.

### Step 4. Wireless Networking

**Wireless Networking**

Enable

•Network ID(SSID):

•Wireless Mode:  Infrastructure  Ad-Hoc

•Channel:

•Authentication:

• Encryption  None  WEP

• Format  ASCII  HEX

• Key Length  64 bits  128 bits

WEP Key 1

WEP Key 2

WEP Key 3

WEP Key 4

Select **Enable** to enable the wireless function of the camera, and then complete the required settings.

## Step 5. Confirm Settings

### Confirm Settings

•Camera Name:	wireless network camera 1
•Location:	classroom 1
•IP Mode:	DHCP
•IP Address:	192.168.0.30
•Subnet Mask:	255.255.255.0
•Default Gateway:	192.168.0.1
•MAC Address:	00:FF:00:05:21:01
•Primary DNS Address:	
•Secondary DNS Address:	
•SMTP Server Address:	
•Sender Email Address:	
•Authentication mode:	None
•Sender User Name:	
•Receiver #1 Email Address:	
•Receiver #2 Email Address:	
•Connection:	Infrastructure
•Channel:	6
•Authentication :	Open
•Encryption :	None

This step shows the configuration of your camera. When you confirm the settings, click **Apply** to finish the wizard and reboot the camera. Otherwise, click **Prev** to go back to the previous step(s) and change the settings; or click **Cancel** to end the wizard and discard the changes.

## 4.3 Basic Setup

The Basic menu contains three sub-menus that provide the system settings for the camera, such as the Camera Name, Location, Date & Time, and User management.

### Basic >> System

#### ■ Basic

- **Camera Name:** Enter a descriptive name for the camera.
- **Location:** Enter a descriptive name for the location used by the camera.

#### ■ Indication LED

This item allows you to set the LED illumination as desired. There are two options: **Normal** and **OFF**.

### Basic >> Date & Time

#### ■ Date & Time

- **TimeZone:** Select the proper time zone for the region from the pull-down menu.
- **Synchronize with PC:** Select this option and the date & time settings of the camera will be synchronized with the connected computer.
- **Synchronize with NTP Server:** Select this option and the time will be synchronized with the NTP Server. You need to enter the IP address of the server and select the update interval in the following two boxes.
- **Manual:** Select this option to set the date and time manually.

## Basic >> User

### ■ Administrator

To prevent unauthorized access to the camera's Web Configuration, you are strongly recommend to change the default administrator password. Type the administrator password twice to set and confirm the password.

### ■ General User

- **User Name:** Enter the user's name you want to add to use the camera.
- **Password:** Enter the password for the new user.

When you are finished, click **Add/Modify** to add the new user to the camera. To modify the user's information, select the one you want to modify from **UserList** and click **Add/Modify**.

- **UserList:** Display the existing users of the camera. To delete a user, select the one you want to delete and click **Delete**.

### ■ Guest

- **User Name:** Enter the guest's name you want to add to use the camera.
- **Password:** Enter the password for the new guest.
- **UserList:** Display the existing guests of the camera. To delete a user, select the one you want to delete and click **Delete**.

**NOTE** The "General User" can access the camera and control the Function buttons of the camera's Web Configuration; the "Guest" can only view the live view image from the main page of the Web Configuration while accessing the camera. Only the "Administrator" is allowed to configure the camera through the Web Configuration.

## 4.4 Network Settings

The Network menu contains three sub-menus that provide the network settings for the camera, such as the IP Setting, DDNS Setting, IP Filter, and Wireless network.

The screenshot displays the web interface for the ALLNET ALL2281 WLAN Camera. The top navigation bar is blue with the ALLNET logo and the camera model name. Below this, there are buttons for 'Live View' and 'Setup'. A 'Smart Wizard' section on the left lists various configuration options, with 'Network' being the active menu. The main content area is titled 'Network >> Network' and contains several sub-sections: 'IP Setting' with radio buttons for DHCP and Static IP, and fields for IP address, Subnet Mask, Default Gateway, Primary DNS, and Secondary DNS; 'DDNS Setting' with an 'Enable' checkbox, a dropdown for Provider (set to 'members.dyndns.org'), and fields for Host Name, User Name, and Password; 'UPnP' with an 'Enable' checkbox; and 'Ports Number' with input fields for HTTP Port (80) and RTSP Port (554).

**ALLNET ALL2281 WLAN Camera**

Live View  
Setup

Smart Wizard

- Basic
- Network
  - Network
  - IP Filter
  - Wireless
- Video/Audio
- Event Server
- Motion Detect
- Event Config
- Tools
- USB
- Information

**Network >> Network**

**IP Setting**

- DHCP
- Static IP
  - IP: 192 . 168 . 1 . 101
  - Subnet Mask: 255 . 255 . 255 . 0
  - Default Gateway: 192 . 168 . 1 . 1
  - Primary DNS: . . . .
  - Secondary DNS: . . . .
- PPPoE
  - User Name:
  - Password:

**DDNS Setting**

- Enable
- Provider: members.dyndns.org
- Host Name:
- User Name:
- Password:

**UPnP**

- Enable

**Ports Number**

- HTTP Port: 80 (default: 80)
- RTSP Port: 554 (default: 554)



## Network >> Network

### ■ IP Setting

This item allows you to select the IP address mode and set up the related configuration.

- **DHCP:** Select this option when your network uses the DHCP server. When the camera starts up, it will be assigned an IP address from the DHCP server automatically.
- **Static IP:** Select this option to assign the IP address for the camera directly. You can use IP Finder to obtain the related setting values.

<b>IP</b>	Enter the IP address of the camera. The default setting is <b>192.168.0.30</b> .
<b>Subnet Mask</b>	Enter the Subnet Mask of the camera. The default setting is <b>255.255.255.0</b> .
<b>Default Gateway</b>	Enter the Default Gateway of the camera. The default setting is <b>192.168.0.1</b> .
<b>Primary/ Secondary DNS</b>	DNS (Domain Name System) translates domain names into IP addresses. Enter the Primary DNS and Secondary DNS that are provided by ISP.

- **PPPoE:** Select this option when you use a direct connection via the ADSL modem. You should have a PPPoE account from your Internet service provider. Enter the **User Name** and **Password**. The camera will get an IP address from the ISP as starting up.

**NOTE** Once the camera get an IP address from the ISP as starting up, it automatically sends a notification email to you. Therefore, when you select PPPoE as your connecting type, you have to set up the email or DDNS configuration in advance.

## DDNS Setting

With the Dynamic DNS feature, you can assign a fixed host and domain name to a dynamic Internet IP address. Select the **Enable** option to enable this feature. Then, select the Provider from the pull-down list and enter the required information in the **Host Name**, **User Name**, and **Password** boxes. Please note that you have to sign up for DDNS service with the service provider first.

### ■ UPnP

The camera supports UPnP (Universal Plug and Play), which is a set of computer network protocols that enable the device-to-device interoperability. In addition, it supports port auto mapping function so that you can access the camera if it is behind an NAT router or firewall. Select the **Enable** option to enable this feature.

### ■ Ports Number

- **HTTP Port:** The default HTTP port is **80**.
- **RTSP Port:** Configure the transmission of streaming data within the network. The default RTSP (Real Time Streaming Protocol) port is **554**.

**NOTE** If the camera is behind an NAT router or firewall, the suggested to be used is from 1024 to 65535.

## Network >> IP Filter

The IP Filter setting allows the administrator of the camera to limit the users within a certain range of IP addresses to access the camera.

### ■ Start/End IP Address

Assign a range of IP addresses that are not allowed to access the camera by entering the Start IP address and End IP address. When you are finished, click **Add** to save the range setting. You can repeat the action to assign multiple ranges for the camera.

For example, when you enter 192.168.0.50 in Start IP Address and 192.168.0.80 in End IP Address, the user whose IP address located within 192.168.0.50 ~ 192.168.0.80 will not be allowed to access the camera.

### ■ Deny IP List

The list displays the range setting(s) of IP addresses that are not allowed to access the camera. To clear the setting, select a range of IP addresses from the list and click **Delete**.

## Network >> Wireless Setting

### ■ Wireless

The camera supports WLAN while you use the wireless network. Select the **Enable** option to enable this feature.

- **Network ID (SSID):** Keep the default setting of this option to connect the camera to any access point under the infrastructure network mode. To connect the camera to a specified access point, set a SSID for the camera to correspond with the access point's ESS-ID. To connect the camera to an Ad-Hoc wireless workgroup, set the same wireless channel and SSID to match with the computer's configuration.

Click **Site Survey** to display the available wireless networks, so that you can easily connect to one of the listed wireless networks.

Network»Wireless Setting

» Wireless

Enable

Network ID(SSID):

ESSID	MAC	Channel	MODE	Privacy	Signal
magumbade	00:12:bf:db:f1:14	6	Infrastructure	Yes	100%
allnet_w	00:0f:a3:1a:f4:d1	6	Infrastructure	Yes	15%
ALL0276 Testger	00:0f:c9:01:df:90	11	Infrastructure	No	100%

Wireless Mode:  Infrastructure  Ad-Hoc

Channel:

Authentication:

Encryption:  TKIP  AES

Pre-Shared Key:

### List of searching results

- **Wireless Mode:** Select the type of wireless communication for the camera: **Infrastructure** or **Ad-Hoc**.
- **Channel:** Select the appropriate channel from the list.
- **Authentication:** Select the authentication method to secure the camera from being used by unauthorized user: **Open**, **Shared-key**, **WPA-PSK**, and **WPA2-PSK**. The following table explains the four options:

<b>Open</b>	The default setting of Authentication mode, which communicates the key across the network.
<b>Shared-key</b>	Allow communication only with other devices with identical WEP settings.
<b>WPA-PSK/ WPA2-PSK</b>	WPA-PSK/WPA2-PSK is specially designed for the users who do not have access to network authentication servers. The user has to manually enter the starting password in their access point or gateway, as well as in each PC on the wireless network.

If you select **Open** or **Shared-key** as the Authentication mode, you need to complete the following settings:

**Encryption:** Select the **WEP** option to enable the data encryption feature to secure the camera within the wireless network.

**Format:** Once you enable the Encryption feature, you need to determine the encryption format by selecting **ASCII** or **HEX**. ASCII format causes each character you type to be interpreted as an eight-bit value. Hex format causes each pair of characters you type to be interpreted as an eight-bit value in hexadecimal (base 16) notation.

**Key Length:** Select the WEP key length you use: **64 bits** or **128 bits**.

**WEP Key 1/2/3/4:** Enter the WEP key(s) in the following boxes.

If you select **WPA-PSK** or **WPA2-PSK** as the Authentication mode, you need to complete the following settings:

**Encryption:** Select **TKIP** or **AES**. TKIP (Temporal Key Integrity Protocol) changes the temporal key every 10,000 packets to insure much greater security than the standard WEP security. AES (Advanced Encryption Standard) is used to ensure the highest degree of security and authenticity for digital information.

**Pre-Shared Key:** This is used to identify each other in the network. Enter the name in the box, and this name must match the Pre-shared key value in the remote device.

## 4.5 Setting up Video & Audio

The Video & Audio menu contains three sub-menus that provide the video and audio settings for the camera.

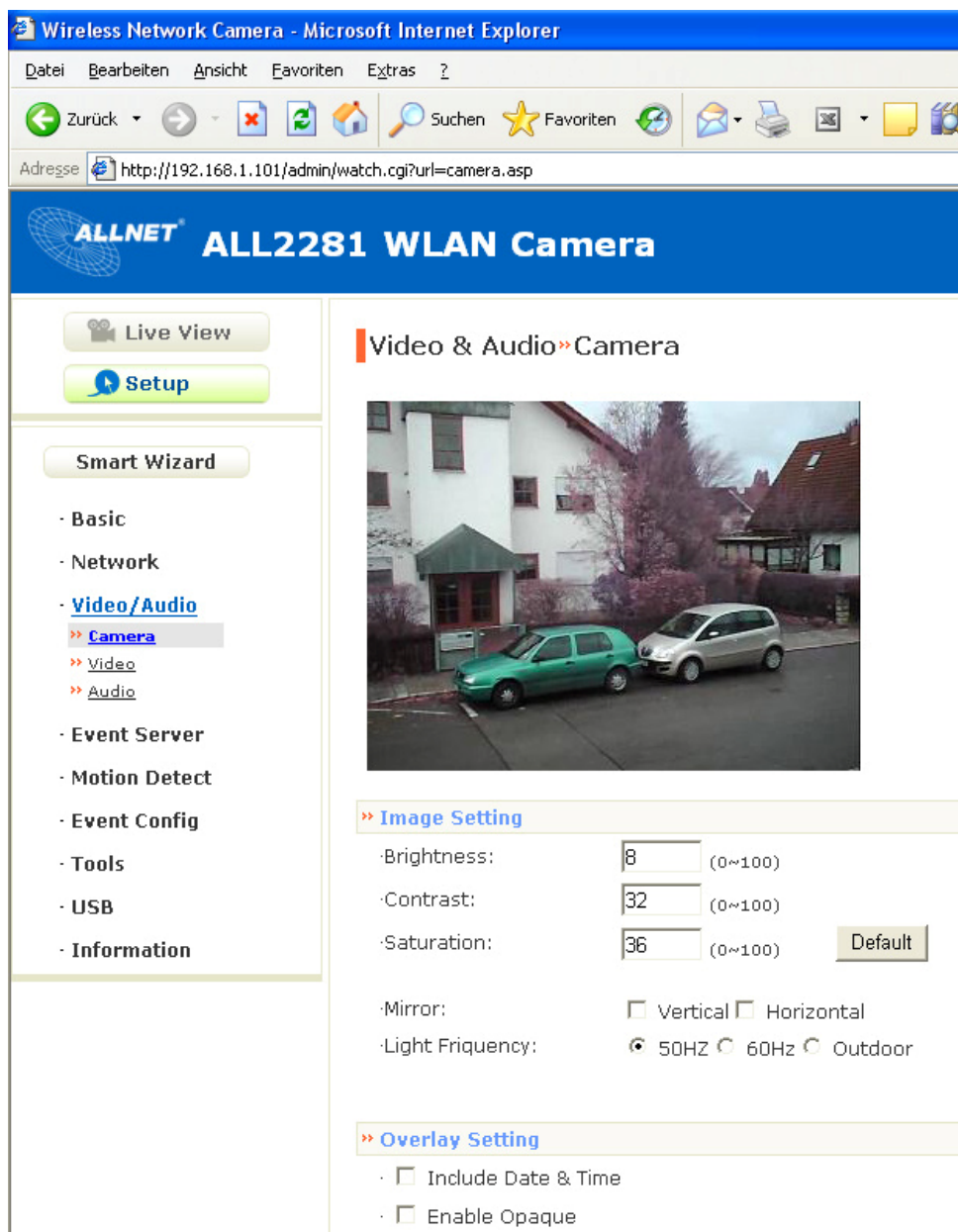

The screenshot shows a web browser window titled "Wireless Network Camera - Microsoft Internet Explorer". The address bar shows the URL "http://192.168.1.101/admin/watch.cgi?url=camera.asp". The page header features the ALLNET logo and the text "ALL2281 WLAN Camera".

On the left side, there is a navigation menu with the following items:

- Live View
- Setup
- Smart Wizard
  - Basic
  - Network
  - Video/Audio
    - Camera (selected)
    - Video
    - Audio
  - Event Server
  - Motion Detect
  - Event Config
  - Tools
  - USB
  - Information

The main content area is titled "Video & Audio»Camera" and displays a live video feed of a street scene with a green car and a silver car parked in front of a building.

Below the video feed, there are two sections for configuration:

**Image Setting**

- Brightness:  (0~100)
- Contrast:  (0~100)
- Saturation:  (0~100)
- Mirror:  Vertical  Horizontal
- Light Frequency:  50HZ  60Hz  Outdoor

**Overlay Setting**

- Include Date & Time
- Enable Opaque

## Video & Audio >> Camera

### ■ Image Setting

- **Brightness:** Adjust the brightness level from 0 ~ 100.
- **Contrast:** Adjust the contrast level from 0 ~ 100.
- **Saturation:** Adjust the colors level from 0 ~ 100.

Click **Default** to restore the default settings of the three options above.

- **Mirror:** Select the **Horizontal** option to mirror the image horizontally. Select the **Vertical** option to mirror the image vertically.
- **Light Frequency:** Select the proper frequency according to the camera's location: **50Hz**, **60Hz**, or **Outdoor**.

### ■ Overlay Setting

- **Includes Date & Time:** Select this option to display the date & time stamp on the live view image.
- **Enable Opaque:** Select this option to set a black background to the displayed date & time stamp.

## Video & Audio >> Video

### ■ MPEG4

- **Video Resolution:** Select the desired video resolution from the three formats: **VGA**, **QVGA** and **QQVGA**. The higher setting (VGA) obtains better video quality while it uses more resource within your network.
- **Video Quality:** Select the desired image quality from five levels: **Lowest**, **Low**, **Medium**, **High**, and **Highest**.
- **Frame Rate:** Select **Auto** or a proper setting depending on your network status.

## ■ MJPEG

- **Video Resolution:** Select the desired video resolution from the three formats: **VGA**, **QVGA** and **QQVGA**. The higher setting (VGA) obtains better video quality while it uses more resource within your network.
- **Video Quality:** Select the desired image quality from five levels: **Lowest**, **Low**, **Medium**, **High**, and **Highest**.
- **Frame Rate:** Select **Auto** or a proper setting depending on your network status.

**NOTE** The camera supports both MPEG4 and MJPEG compression. MJPEG capture the images in JPEG format, which require higher bandwidth to view smooth video. The administrator can control the bandwidth of each connection well through the setting options above.

## ■ 3GPP

The camera supports 3GPP specification. Select the **Disable** option to disable this feature. Otherwise, select **3GPP Without Audio** or **3GPP With Audio** to transfer the video clips without or with audio.

If you use a mobile phone that supports 3GPP, you can also view the real-time streaming image captured by the camera on your phone (with the default player on the phone) by entering the RTSP link: [rtsp://\(IP address of the camera\)/3gp](rtsp://(IP address of the camera)/3gp).



## Video & Audio >> Audio

### ■ Camera Microphone In

Select the **Enable** option to enable the camera's audio function, so that you can receive the on-site sound and voice from the camera.

### ■ Camera Speaker Out

This option is displayed when you connect a 2-way audio camera. Select the **Enable** option to enable the camera's external speaker function, so that the connected speaker can play the sound and voice through the camera.

- **Volume:** Set the speaker's volume.

## 4.6 Event Server Configuration

The Event Server menu contains three sub-menus that allow you to upload images to FTP, send emails that include still images, and store the images to a NAS system.

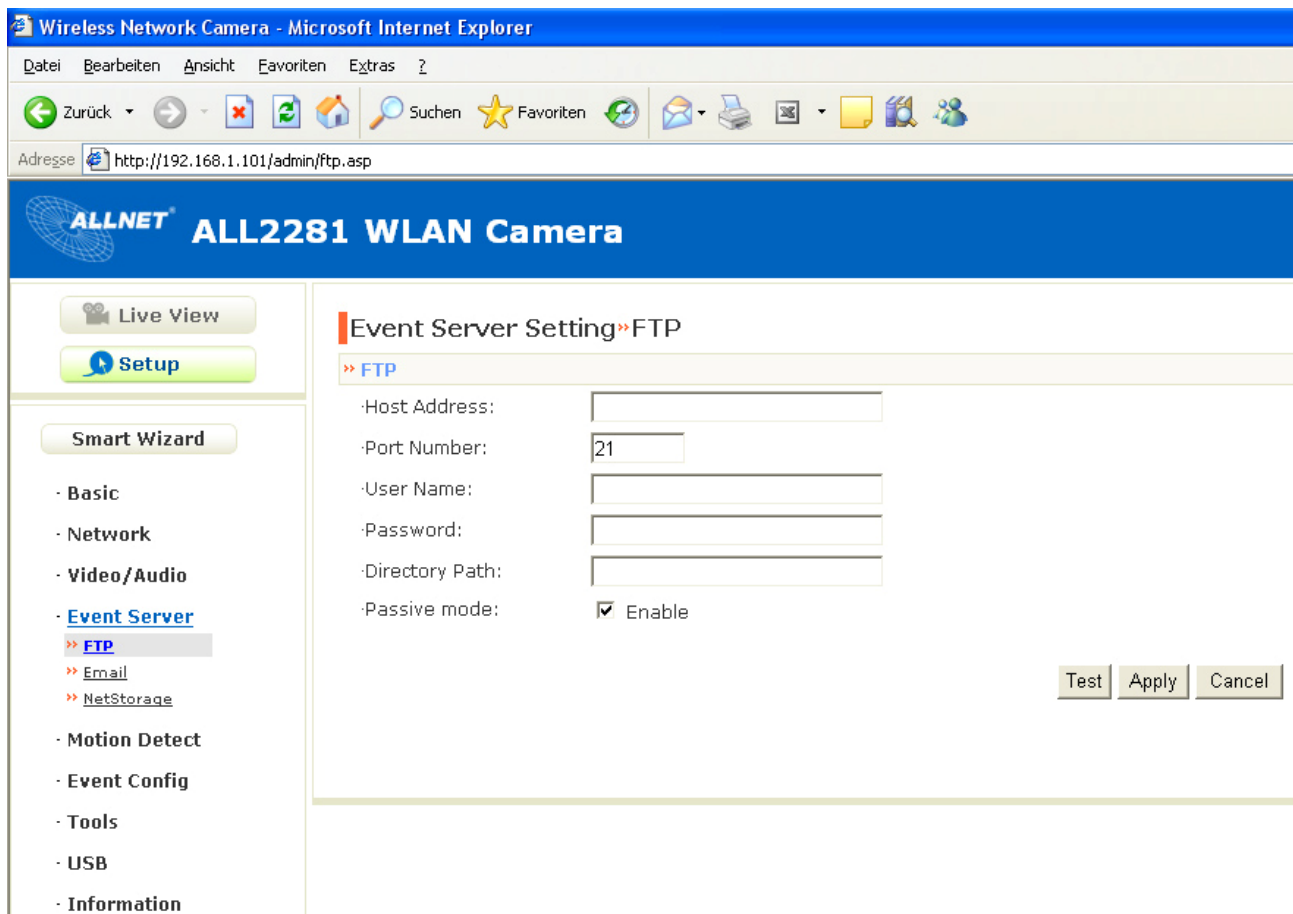

The screenshot shows a web browser window titled "Wireless Network Camera - Microsoft Internet Explorer". The address bar shows "http://192.168.1.101/admin/ftp.asp". The page header displays the "ALLNET ALL2281 WLAN Camera" logo. On the left side, there is a navigation menu with options: "Live View", "Setup", "Smart Wizard", "Basic", "Network", "Video/Audio", "Event Server" (expanded to show "FTP", "Email", and "NetStorage"), "Motion Detect", "Event Config", "Tools", "USB", and "Information". The main content area is titled "Event Server Setting >> FTP" and contains the following configuration fields:

- Host Address:
- Port Number:
- User Name:
- Password:
- Directory Path:
- Passive mode:  Enable

At the bottom right of the configuration area, there are three buttons: "Test", "Apply", and "Cancel".

When you complete the required settings for FTP, Email, or Network Storage, click **Test** to test the related configuration is correct or not. Once the camera connects to the server successfully, click **Apply**.

## Event Server Setting>> FTP

### ■ FTP

- **Host Address:** Enter the IP address of the target FTP server.
- **Port Number:** Enter the port number used for the FTP server.
- **User Name:** Enter the user name to login into the FTP server.
- **Password:** Enter the password to login into the FTP server.
- **Directory Path:** Enter the destination folder for uploading the images. For example, */Test/*.
- **Passive Mode:** Select the **Enable** option to enable passive mode.

## Event Server Setting >> Email

### ■ Email

- **SMTP Server Address:** Enter the mail server address. For example, *[mymail.com](#)*.
- **Sender Email Address:** Enter the email address of the user who will send the email. For example, *[allnet@mymail.com](#)*.
- **Sender User Name:** Enter the user name to login the mail server.
- **Sender Password:** Enter the password to login the mail server.
- **Receiver #1 Email Address:** Enter the first email address of the user who will receive the email.
- **Receiver #2 Email Address:** Enter the second email address of the user who will receive the email.

## Event Server Setting >> Network Storage

### ■ Net Storage

- **Samba Server Address:** Enter the IP address of the Network Storage server.
- **Share:** Assign the folder on the Network Storage server to share the files to users.
- **Path:** Assign the path for uploading the files on the Network Storage server. For example, **/Test/**.
- **User Name:** Enter the user name to login into the Network Storage server.
- **Password:** Enter the password to login into the Network Storage server.
- **Split By:** When the file is too large to upload smoothly, use this option to split it by selecting **File Size** or **Recording Time**.
- **When Disk Full:** Select **Stop Recording** or **Recycle – Delete Oldest Folder of File** when the storage space on the Network Storage server is full.

## 4.7 Motion Detect

The Motion Detect menu contains the command and option that allow you to enable and set up the motion detection feature of the camera. The camera provides two detecting areas.

To enable the detecting area, select **Window 1** or **2** from the pull-down list, and then select **Enable**. When the detecting area is enabled, you can use the mouse to move the detecting area and change the area coverage.

Motion Detection » Detection Configuration

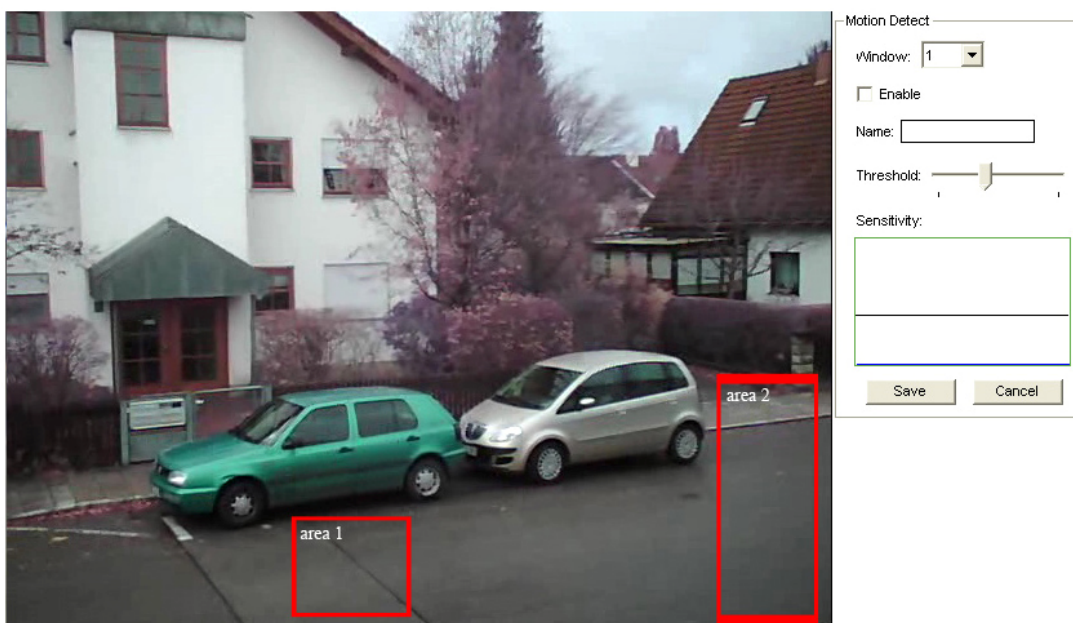

- **Name:** Assign a name to the detecting area.
- **Threshold:** Move the slide bar to adjust the level for detecting motion to record video.

## 4.8 Event Config

The Event Config menu contains four sub-menus that provide the commands to configure event profiles.

The screenshot shows a web browser window titled "Wireless Network Camera - Microsoft Internet Explorer". The address bar displays "http://192.168.1.101/admin/general.asp". The page header features the ALLNET logo and "ALL2281 WLAN Camera". On the left side, there is a navigation menu with buttons for "Live View", "Setup", and "Smart Wizard". Below these are several menu items: "Basic", "Network", "Video/Audio", "Event Server", "Motion Detect", "Event Config" (which is expanded to show "General", "Schedule Profile", "Motion Trigger", and "Schedule Trigger"), "Tools", "USB", and "Information". The main content area is titled "Event Configuration >> General Setting" and contains two configuration fields: "Snapshot/Recording Subfolder:" with an empty text input box, and "Network Storage Recording Time Per Event:" with a numeric input box containing "20" and the unit "secs". At the bottom right of the configuration area, there are "Apply" and "Cancel" buttons.

### Event Configuration >> General Setting

- **Snapshot/Recording Filename Prefix:** You can assign a given prefix to each new captured file. Otherwise, leave this option blank to use the default setting.
- **Network Storage Recording Time Per Even:** Limit the recording time while you are using the Network Storage solution.

## Event Configuration >> Arrange Schedule Profile

This sub-menu displays the scheduled profile(s). To customize the profile, click **Add** and then enter a descriptive name for the profile in the prompt dialog window. After entering the profile name, click **OK** and the profile is added to the Schedule Profiles list. To delete the profile, select the profile in the list and click **Delete**.

Event Configuration >> Arrange Schedule Profile

>> Schedule Profiles

classroom1

Add Delete

-Profile Name: classroom1

-Weekdays:  Sun  Mon  Tue  Wed  Thr  Fri  Sat

-Time List: 09:00 - 12:00  
13:00 - 17:00

Add Delete Add this to all weekdays Delete this from all weekdays

-Start Time: 13 : 00

-End Time: 17 : 00

Save

- **Profile Name:** Display the profile name that you select in the Schedule Profiles list.
- **Weekdays:** Select the weekday(s) that you want to separately assign in the schedule profile. The weekday that has been assigned will be displayed with green color.
- **Time List:** Display the time period that you have assigned within the selected weekday. To assign the same time period to every weekday, click **Add this to all weekdays**; click **Delete this from all weekdays** to remove the selected time period from every weekday. Click **Delete** to remove the selected time period.
- **Start/End Time:** Enter the start and end time and then click **Add** to assign a time period within in the selected weekday.

## Event Configuration >> Motion Detect Trigger

Select the **Enable** option to enable the trigger function of the camera, so that you can send captured images within the detecting area to the FTP server, email receiver, Network Storage server, or the connected USB device. You have to configure corresponding settings, such as FTP server and email server, to enable this feature.

- **Schedule Profile:** Select a schedule profile from the pull-down list.
- **Action:** Select the destination that the captured images will be sent to: **Send Email, FTP Upload, Record to Network Storage, or Save Image to USB.**

## Event Configuration >> Schedule Trigger

You can separately configure the schedule for trigger function of the camera by **Email, FTP, or Network Storage**. Select the **Enable** option on each item, and then select a **Schedule Profile** from the pull-down list and set the **Interval** time.

**NOTE** If the setting value of the **Network Storage Recording Time Per Event** option in General Setting is longer than the **Interval** time in Network Storage Schedule, the recorded file will be a continuous video clip.

For example, if you set the **Network Storage Recording Time Per Event** as 10 seconds and the **Interval** as 5 seconds, recorded file becomes a non-stop video clip because the camera will record a 10-second video clip every 5 seconds.



## 4.9 Tools

The Tools menu provides the commands that allow you to restart or reset the camera. You can also backup and restore your configuration, and upgrade the firmware for the camera.

The screenshot shows a web browser window titled "Wireless Network Camera - Microsoft Internet Explorer". The address bar shows "http://192.168.1.101/admin/tools.asp". The page header displays the "ALLNET" logo and "ALL2281 WLAN Camera".

On the left side, there is a navigation menu with the following items:

- Live View
- Setup
- Smart Wizard
  - Basic
  - Network
  - Video/Audio
  - Event Server
  - Motion Detect
  - Event Config
  - **Tools**
  - USB
  - Information

The main content area is titled "System Tools» Tools" and contains the following sections:

- Factory Reset**: "Factory reset will restore all the setting" with a "Reset" button.
- System Reboot**: "System will be rebooted" with a "Reboot" button.
- Configuration**:
  - Backup: "Get the backup file" button.
  - Restore: A text input field, a "Durchsuchen..." button, and a "Restore" button.
- Update Firmware**:
  - Current Firmware Version : 1.0.0 build:7
  - Select the firmware : A text input field, a "Durchsuchen..." button, and an "Update" button.

## Factory Reset

Click **Reset** to restore all factory default settings for the camera.

### ■ System Reboot

Click **Reboot** to restart the camera just like turning the device off and on. The camera configuration will be retained after rebooting.

### ■ Configuration

You can save your camera configuration as a backup file on your computer. Whenever you want to resume the original settings, you can restore them by retrieving the backup file.

- **Backup:** Click **Get the backup file** to save the current configuration of the camera.
- **Restore:** Click **Browse** to locate the backup file and then click **Restore**.

### ■ Update Firmware

This item displays the current firmware version. You can upgrade the firmware for your camera once you obtained a latest version of firmware.

- **Select the firmware:** Click **Browse** to locate the backup file and then click **Update**.

**NOTE** Make sure to keep the camera connected to the power source during the process of upgrading firmware. Otherwise, the camera might be damaged because of failure of upgrading firmware.

## 4.10 USB

The USB menu provides the information and controls of the connected USB device.

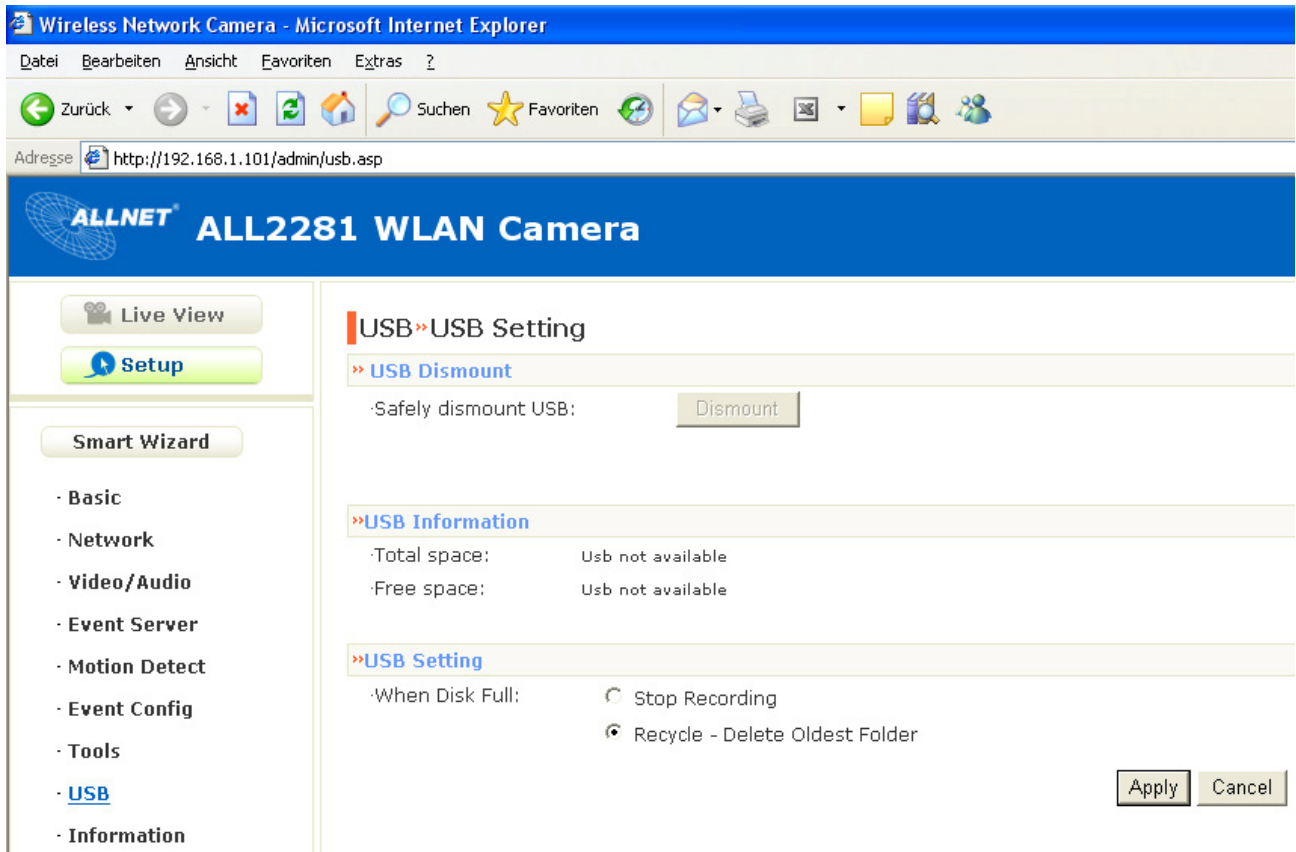

The screenshot shows a web browser window titled "Wireless Network Camera - Microsoft Internet Explorer". The address bar displays "http://192.168.1.101/admin/usb.asp". The page header features the ALLNET logo and the text "ALL2281 WLAN Camera".

The interface is divided into a left sidebar and a main content area. The sidebar contains the following menu items:

- Live View
- Setup
- Smart Wizard
  - Basic
  - Network
  - Video/Audio
  - Event Server
  - Motion Detect
  - Event Config
  - Tools
  - USB**
  - Information

The main content area is titled "USB»USB Setting" and contains three sections:

- »USB Dismount**: Includes a "Safely dismount USB:" label and a "Dismount" button.
- »USB Information**: Displays "Total space: Usb not available" and "Free space: Usb not available".
- »USB Setting**: Includes a "When Disk Full:" label and two radio button options: "Stop Recording" (unselected) and "Recycle - Delete Oldest Folder" (selected).

At the bottom right of the main content area, there are "Apply" and "Cancel" buttons.

## ■ **USB Dismount**

To safely remove the connected USB device, you can press the Unmount button for four seconds on the camera or click **Dismount** from this item.

## ■ **USB Information**

Display the **Total space** and **Free space** of the USB device.

## ■ **USB Setting**

- **When Disk Full:** Select **Stop Recording** or **Recycle – Delete Oldest Folder of File** when the storage space on the USB device is full.

**NOTE** The connected USB storage device can be only used to store still images.

## 4.11 Information

The Information menu displays the current configuration and events log of the camera.

The screenshot shows the web interface for the ALLNET ALL2281 WLAN Camera. The top header is blue with the ALLNET logo and the camera model name. Below the header, there are buttons for 'Live View', 'Setup', and 'Smart Wizard'. A sidebar menu on the left lists various configuration categories: Basic, Network, Video/Audio, Event Server, Motion Detect, Event Config, Tools, USB, Information, Device Info (highlighted), and System Log. The main content area displays 'System Information' with a sub-menu for 'Device Information'. This sub-menu is expanded to show four sections: Basic, Video & Audio, Network, and Wireless, each containing a list of configuration parameters and their values.

System Information » Device Information	
» Basic	
-Camera Name:	ALL2281
-Location:	Technik
-Firmware Version:	1.0.0 build: 7
» Video & Audio	
-MPEG4 Resolution:	VGA
-MJPEG Resolution:	VGA
-3GPP Enable:	Disable
-Microphone In:	Enable
-Speaker Out:	Enable
» Network	
-IP MODE:	Static
-IP Address:	192.168.1.101
-Subnet Mask:	255.255.255.0
-Default Gateway:	192.168.1.1
-MAC Address:	00:FF:00:06:13:01
-Primary DNS Address:	
-Secondary DNS address:	
-UPnP Enable :	Enable
-HTTP Port:	80
-RTSP Port:	554
» Wireless	
-ESSID:	magumbade
-Connection:	Infrastructure
-Channel:	6
-Authentication :	WPA-PSK
-Encryption :	TKIP

### ■ Device Info

Display the Basic, Video & Audio, Network, and Wireless settings of the camera.

### ■ System Log

The Logs table displays the events log recorded by the system.

# CHAPTER 5

---

## APPENDIX

### A.1 Specification

#### ■ Image Sensor

<b>Sensor</b>	1/4" color CMOS
<b>Resolution</b>	640x480

#### ■ Video

<b>Compression</b>	MPEG4/MJPEG
<b>Video resolution</b>	VGA/QVGA/QQVGA; 30fps max.

#### ■ System Hardware

<b>Processor</b>	ARM9 base
<b>RAM</b>	32MB SDRAM
<b>ROM</b>	8MB NOR Flash
<b>Power</b>	DC 5V

#### ■ Communication

<b>LAN</b>	10/100Mbps Fast Ethernet, auto-sensed, Auto-MDIX
<b>WLAN</b>	IEEE 802.11b/g
<b>Protocol support</b>	TCP/IP, UDP, ICMP, DHCP, NTP, DNS, DDNS, SMTP, FTP, Samba, PPPoE, UPnP, RTP, RTSP, RTCP

■ **User Interface**

<b>LAN</b>	One RJ-45 port
<b>Antenna</b>	One external antenna
<b>Reset</b>	One Reset button
<b>USB</b>	USB 1.1 port, with one unmount button; Power distribution: 500mA Max. Support FAT,FAT32 file system
<b>LEDs</b>	Power LED (amber); Link LED (green)

■ **Audio**

<b>Input</b>	Built-in MIC
<b>Output</b>	Headphone output jack (Mono)
<b>Codec</b>	PCM/AMR (AMR is for 3GPP only)

■ **Software**

<b>OS Support</b>	Windows 2000/XP/Vista
<b>Browser</b>	Internet Explorer 6.0 or above Apple Safari 2 or above Mozilla Firefox 2.00 or above

<b>Software</b>	Ultra View for playback/recording/ configuration features
-----------------	--

■ **Operating Environment**

<b>Temperature</b>	- Operation: 5°C ~ 45°C - Storage: -15°C ~ 60°C
<b>Humidity</b>	- Operation: 20% ~ 85% non-condensing - Storage: 0% ~ 90% non-condensing

■ **EMI**

FCC Class B, CE Class B

## A.2 Glossary of Terms

### NUMBERS

- 10BASE-T** 10BASE-T is Ethernet over UTP Category III, IV, or V unshielded twisted-pair media.
- 100BASE-TX** The two-pair twisted-media implementation of 100BASE-T is called 100BASE-TX.

### A

- ADPCM** Adaptive Differential Pulse Code Modulation, a new technology improved from PCM, which encodes analog sounds to digital form.
- AMR** AMR (Adaptive Multi-Rate) is an audio data compression scheme optimized for speech coding, which is adopted as the standard speech codec by 3GPP.
- Applet** Applets are small Java programs that can be embedded in an HTML page. The rule at the moment is that an applet can only make an Internet connection to the computer from that the applet was sent.
- ASCII** American Standard Code For Information Interchange, it is the standard method for encoding characters as 8-bit sequences of binary numbers, allowing a maximum of 256 characters.
- ARP** Address Resolution Protocol. ARP is a protocol that resides at the TCP/IP Internet layer that delivers data on the same network by translating an IP address to a physical address.
- AVI** Audio Video Interleave, it is a Windows platform audio and video file type, a common format for small movies and videos.

### B

- BOOTP** Bootstrap Protocol is an Internet protocol that can automatically configure a network device in a diskless workstation to give its own IP address.



## C

**Communication** Communication has four components: sender, receiver, message, and medium. In networks, devices and application tasks and processes communicate messages to each other over media. They represent the sender and receivers. The data they send is the message. The cabling or transmission method they use is the medium.

**Connection** In networking, two devices establish a connection to communicate with each other.

## D

**DHCP** Developed by Microsoft, DHCP (Dynamic Host Configuration Protocol) is a protocol for assigning dynamic IP addresses to devices on a network. With dynamic addressing, a device can have a different IP address every time it connects to the network. In some systems, the device's IP address can even change while it is still connected. It also supports a mix of static and dynamic IP addresses. This simplifies the task for network administrators because the software keeps track of IP addresses rather than requiring an administrator to manage the task. A new computer can be added to a network without the hassle of manually assigning it a unique IP address. DHCP allows the specification for the service provided by a router, gateway, or other network device that automatically assigns an IP address to any device that requests one.

**DNS** Domain Name System is an Internet service that translates domain names into IP addresses. Since domain names are alphabetic, they're easier to remember. The Internet however, is really based on IP addresses every time you use a domain name the DNS will translate the name into the corresponding IP address. For example, the domain name *www.network\_camera.com* might translate to *192.167.222.8*.

## E

### **Enterprise network**

An enterprise network consists of collections of networks connected to each other over a geographically dispersed area. The enterprise network serves the needs of a widely distributed company and operates the company's mission-critical applications.

### **Ethernet**

The most popular LAN communication technology. There are a variety of types of Ethernet, including 10Mbps (traditional Ethernet), 100Mbps (Fast Ethernet), and 1,000Mbps (Gigabit Ethernet). Most Ethernet networks use Category 5 cabling to carry information, in the form of electrical signals, between devices. Ethernet is an implementation of CSMA/CD that operates in a bus or star topology.

## F

### **Fast Ethernet**

Fast Ethernet, also called 100BASE-T, operates at 10 or 100Mbps per second over UTP, STP, or fiber-optic media.

### **Firewall**

Firewall is considered the first line of defense in protecting private information. For better security, data can be encrypted. A system designed to prevent unauthorized access to or from a private network. Firewalls are frequently used to prevent unauthorized Internet users from accessing private networks connected to the Internet, especially Intranets all messages entering or leaving the intranet pass through the firewall, which examines each message and blocks those that do not meet the specified security criteria.

## G

### **Gateway**

A gateway links computers that use different data formats together.

### **Group**

Groups consist of several user machines that have similar characteristics such as being in the same department.

## H

### **HEX**

Short for hexadecimal refers to the base-16 number system, which consists of 16 unique symbols: the numbers 0 to 9 and the letters A to F. For example, the decimal number 15 is represented as F in the hexadecimal numbering system. The hexadecimal system is useful because it can represent every byte (8 bits) as two consecutive hexadecimal digits. It is easier for humans to read hexadecimal numbers than binary numbers.

## I

### **Intranet**

This is a private network, inside an organization or company that uses the same software you will find on the public Internet. The only difference is that an Intranet is used for internal usage only.

### **Internet**

The Internet is a globally linked system of computers that are logically connected based on the Internet Protocol (IP). The Internet provides different ways to access private and public information worldwide.

### **Internet address**

To participate in Internet communications and on Internet Protocol-based networks, a node must have an Internet address that identifies it to the other nodes. All Internet addresses are IP addresses

### **IP**

Internet Protocol is the standard that describes the layout of the basic unit of information on the Internet (the *packet*) and also details the numerical addressing format used to route the information. Your Internet service provider controls the IP address of any device it connects to the Internet. The IP addresses in your network must conform to IP addressing rules. In smaller LANs, most people will allow the DHCP function of a router or gateway to assign the IP addresses on internal networks.

### **IP address**

IP address is a 32-binary digit number that identifies each sender or receiver of information that is sent in packets across the Internet. For example 80.80.80.69 is an IP address. When you “call” that number, using any connection methods, you get connected to the computer

that “owns” that IP address.

## **ISP**

ISP (Internet Service Provider) is a company that maintains a network that is linked to the Internet by way of a dedicated communication line. An ISP offers the use of its dedicated communication lines to companies or individuals who can't afford the high monthly cost for a direct connection.

## **J**

### **JAVA**

Java is a programming language that is specially designed for writing programs that can be safely downloaded to your computer through the Internet without the fear of viruses. It is an object-oriented multi-thread programming best for creating applets and applications for the Internet, Intranet and other complex, distributed network.

## **L**

### **LAN**

Local Area Network a computer network that spans a relatively small area sharing common resources. Most LANs are confined to a single building or group of buildings.

## **M**

### **MJPEG**

MJPEG (Motion JPEG) composes a moving image by storing each frame of a moving picture sequence in JPEG compression, and then decompressing and displaying each frame at rapid speed to show the moving picture.

### **MPEG4**

MPEG4 is designed to enable transmission and reception of high-quality audio and video over the Internet and next-generation mobile telephones.

## N

### **NAT**

Network Address Translator generally applied by a router that makes many different IP addresses on an internal network appear to the Internet as a single address. For routing messages properly within your network, each device requires a unique IP address. But the addresses may not be valid outside your network. NAT solves the problem. When devices within your network request information from the Internet, the requests are forwarded to the Internet under the router's IP address. NAT distributes the responses to the proper IP addresses within your network.

### **Network**

A network consists of a collection of two or more devices, people, or components that communicate with each other over physical or virtual media. The most common types of network are:

**LAN** – (local area network): Computers are in close distance to one another. They are usually in the same office space, room, or building.

**WAN** – (wide area network): The computers are in different geographic locations and are connected by telephone lines or radio waves.

### **NWay Protocol**

A network protocol that can automatically negotiate the highest possible transmission speed between two devices.

## P

### **PCM**

PCM (Pulse Code Modulation) is a technique for converting analog audio signals into digital form for transmission.

### **PING**

Packet Internet Groper, a utility used to determine whether a specific IP address is accessible. It functions by sending a packet to the specified address and waits for a reply. It is primarily used to troubleshoot Internet

connections.

## **PPPoE**

Point-to-Point Protocol over Ethernet. PPPoE is a specification for connecting the users on an Ethernet to the Internet through a common broadband medium, such as DSL or cable modem. All the users over the Ethernet share a common connection.

## **Protocol**

Communication on the network is governed by sets of rules called protocols. Protocols provide the guidelines devices use to communicate with each other, and thus they have different functions. Some protocols are responsible for formatting and presenting and presenting data that will be transferred from file server memory to the file server's network adapter Others are responsible for filtering information between networks and forwarding data to its destination. Still other protocols dictate how data is transferred across the medium, and how servers respond to workstation requests and vice versa. Common network protocols responsible for the presentation and formatting of data for a network operating system are the Internetwork Packet Exchange (IPX) protocol or the Internet Protocol (IP). Protocols that dictate the format of data for transfers the medium include token-passing and Carrier Sense Multiple Access with Collision Detection (CSMA/CD), implemented as token-ring, ARCNET, FDDI, or Ethernet. The Router Information Protocol (RIP), a part of the Transmission Control Protocol/Internet Protocol (TCP/IP) suite, forwards packets from one network to another using the same network protocol.

## **R**

### **RJ-45**

RJ-45 connector is used for Ethernet cable connections.

### **Router**

A router is the network software or hardware entity charged with routing packets between networks.

### **RTP**

RTP (Real-time Transport Protocol) is a data transfer protocol defined to deliver **live media** to the clients at the same time, which defines the transmission of video and

audio files in real time for Internet applications.

## **RTSP**

RTSP (Real-time Streaming Protocol) is the standard used to transmit **stored media** to the client(s) at the same time, which provides client controls for random access to the content stream.

## **S**

### **Server**

It is a simple computer that provides resources, such as files or other information.

### **SIP**

SIP (Session Initiated Protocol) is a standard protocol that delivers the real-time communication for Voice over IP (VoIP), which establishes sessions for features such as audio and video conferencing.

### **SMTP**

The Simple Mail Transfer Protocol is used for Internet mail.

### **SNMP**

Simple Network Management Protocol. SNMP was designed to provide a common foundation for managing network devices.

### **Station**

In LANs, a station consists of a device that can communicate data on the network. In FDDI, a station includes both physical nodes and addressable logical devices. Workstations, single-attach stations, dual-attach stations, and concentrators are FDDI stations.

### **Subnet mask**

In TCP/IP, the bits used to create the subnet are called the subnet mask.

## **T**

### **(TCP/IP)**

Transmission Control Protocol/Internet Protocol is a widely used transport protocol that connects diverse computers of various transmission methods. It was developed by the Department of Defense to connect different computer types and led to the development of the Internet.

### **Transceiver**

A transceiver joins two network segments together. Transceivers can also be used to join a segment that uses one medium to a segment that uses a different medium. On a 10BASE-5 network, the transceiver connects the network adapter or other network device to the medium. Transceivers also can be used on 10BASE-

2 or 10BASE-T networks to attach devices with AUI ports

## U

### **UDP**

The User Datagram Protocol is a connectionless protocol that resides above IP in the TCP/IP suite

### **User Name**

The USERNAME is the unique name assigned to each person who has access to the LAN.

### **Utility**

It is a program that performs a specific task.

### **UTP**

Unshielded twisted-pair. UTP is a form of cable used by all access methods. It consists of several pairs of wires enclosed in an unshielded sheath.

## W

### **WAN**

Wide-Area Network. A wide-area network consists of groups of interconnected computers that are separated by a wide distance and communicate with each other via common carrier telecommunication techniques.

### **WEP**

WEP is widely used as the basic security protocol in Wi-Fi networks, which secures data transmissions using 64-bit or 128-bit encryption.

### **Windows**

Windows is a graphical user interface for workstations that use DOS.

### **WPA**

WPA (Wi-Fi Protected Access ) is used to improve the security of Wi-Fi networks, replacing the current WEP standard. It uses its own encryption, Temporal Key Integrity Protocol (TKIP), to secure data during transmission.

### **WPA2**

Wi-Fi Protected Access 2, the latest security specification that provides greater data protection and network access control for Wi-Fi networks. WPA2 uses the government-grade AES encryption algorithm and IEEE 802.1X-based authentication, which are required to secure large corporate networks.



## CE Declaration

EC – Declaration of conformity for ALL2281 Wireless MPEG4/MJPEG Network Camera



This equipment conforms with the requirements of the Council Directive 89/336/EEC on the approximation of the laws of the member states relating to Radio and Telecommunication Terminal Equipment and the mutual recognition of their conformity.

The safety advice in the documentation accompanying the products shall be obeyed.  
The conformity to the above directive is indicated by the CE sign on the device.  
The ALLNET ALL7960 conforms to the European Council Directives 89/336/EEC.  
This equipment meets the following conformance standards:

**EN:**            **61000-3-2: 2000**  
                  **61000-3-3: 1995 + A1: 2001**  
                  **55022: 1998 + A1: 2000 + A2: 2003 ClassB**  
                  **55024: 1998 + A1: 2001 + A2: 2003**

**IEC:**           **61000-4-2: 1995 + A1: 1998 + A2: 2000**  
                  **61000-4-3: 2002 + A1: 2002**  
                  **61000-4-4: 2004**  
                  **61000-4-5: 1995 + A1: 2000**  
                  **61000-4-6: 1996 + A1: 2000**  
                  **61000-4-8: 1993 + A1: 2000**  
                  **61000-4-11: 2004**

This equipment is intended to be operated in all countries.  
This declaration is made by

ALLNET Computersysteme GmbH  
Maistr. 2  
82110 Germering

and can be downloaded from <http://www.allnet.de/ce-certificates/>

## **GPL Licensed Declaration**

### DISCLAIMER FOR ALLNET-PRODUCTS WHICH CONTAIN GPL-LICENSED SOFTWARE

The Allnet-product you have bought is using Linux software and parts of the netfilter/iptables-project. ([www.netfilter.org](http://www.netfilter.org)), which both are licensed using the GPL (General Public License, available for download at ([www.gnu.org/home.de.html](http://www.gnu.org/home.de.html))).

You can download the complete source-code of this product at [www.allnet.de](http://www.allnet.de) in the download-area for this model.

ALLNET GmbH  
Maistraße 2  
82110 Germering

Tel.: +49 89 / 894 222 22

Fax: +49 89 / 894 222 33

[sales@allnet.de](mailto:sales@allnet.de)  
[www.allnet.de](http://www.allnet.de)

Attention:

Please be aware that any modifications of the firmware for this device will void the warranty. All modifications will be on your own risk and, in case of any damage to the device, Allnet can not repair or replace the device free of charge.