

SP814 MOTION DETECTOR



The Motion Detector is a Z-Wave™ enabled device which is fully compatible with any Z-Wave™ enabled network. Z-Wave™ enabled devices displaying the Z-Wave™ logo can also be used with it regardless of the manufacturer, and ours can also be used in other manufacturer's Z-Wave™ enabled networks. This Motion Detector can control our modules via controller setting. Inclusion of this Motion Detector on other manufacturer's Wireless Controller menu allows remote turn-on of connected modules when the detector is triggered.

The Motion Detector is designed with two detecting sensors, Passive Infra-Red (PIR) sensor and light sensor, in order to fulfill the purpose of security and home automation. When the detector is cooperated with security appliances, it is acting as a security device by detecting changes in infra-red radiation levels. If a person moves within or across the device field of vision, a trigger radio signal will be transmitted to cause full alarm condition in order to frighten intruders away. Alternatively, when the detector is worked with home automation appliances, the detector can be set to perform the role of home automation device by detecting both changes in infra-red radiation levels and percentage of lux levels. Once night falls, the percentage of ambient illumination is lower than preset value. If a person moves within or across the device field of vision, a trigger radio signal will be transmitted so as to turn on the connected lightings for better illumination.

Two mounting methods are provided for varying detection range. The detector can be mounted on a wall for farther detecting distance but narrower coverage; while for ceiling mounting, shorter detecting distance can be made but desired coverage can be expected at user's disposal.

Product Overview

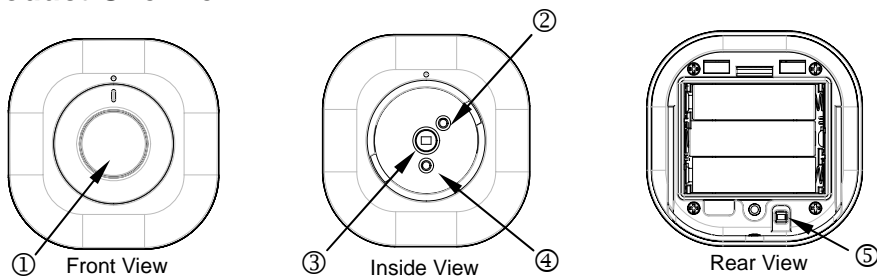

① Lens Cover (wall-lens cover and ceiling-lens cover)	④ Two-Color Indication LED (red & green)
② Photocell Sensor	⑤ Link Key
③ PIR Sensor	

Include to or Exclude from Z-Wave™ Network

In the rear casing, there is a link key which is used to carry out inclusion, exclusion, association or reset. When the detector is first powered up, the LED flashes on and off alternately and repeatedly at 2-second intervals. It implies that it has not been assigned a node ID and cannot work with Z-Wave enabled devices. Please get familiar with the terms below before starting the operations.

Function	Description
Inclusion	Add a Z-Wave enabled device (e.g. Motion Detector) to Z-Wave network.
Exclusion	Delete a Z-Wave enabled device (e.g. Motion Detector) from the network.
Association	After inclusion, you have to define the relationship between devices. Through association, device can be assigned as master/slave, and specify which slave is going to be controlled by which master.
Reset	Restore Detector to factory default.

The table below lists an operation summary of basic Z-Wave functions. Please refer to the instructions for your Z-Wave™ Certificated Primary Controller to access the setup function, and to include/exclude/associate devices.

Function	Description	Indication
No node ID	The Z-Wave Controller does not allocate a node ID to the unit.	2-second on, 2-second off
Inclusion	1. Have Z-Wave Controller entered inclusion mode.	Detector beeps when link key is pressed.
	2. Pressing link key 3 times within 1.5 second will enter inclusion mode. The Detector will stay "awake" for 10 minutes to allow time for setting and device status enquiring.	
Exclusion	1. Have Z-Wave Controller entered exclusion mode.	Detector beeps when link key is pressed.
	2. Pressing link key 3 times within 1.5 second will enter exclusion mode. The Detector will stay "awake" for 10 minutes to allow time for setting and device status enquiring.	
Reset	1. Press link key 3 times within 1.5 second.	Detector beeps when link key is pressed.
	2. Within 1 second, press and hold link key until beep stops.	A long beep is sounded for 5 seconds.
	3. IDs are excluded and all of preset value will be reset to factory default.	2-second on, 2-second off

Function	Description	Indication
Association	1. Have Z-Wave Controller entered association mode.	
	2. When pressing link key 3 times within 1.5 seconds will enter association mode.	Detector beeps when link key is pressed.
	3. There are two groupings – 1 and 2. Refer to Z-Wave's Grouping as described on page 4.	
※Including a node ID allocated by Z-Wave Controller means inclusion. Excluding a node ID allocated by Z-Wave Controller means exclusion. ※Failed or success in including/excluding the node ID can be viewed from the Z-Wave Controller.		

Choosing a Mounting Location

The Motion Detector can be mounted either on a wall or under a ceiling. Before selecting a position for Motion Detector, the following points should be noted:

- Do not position the detector facing a window/fan/air-conditioner or direct sunlight.
- Do not position the detector directly above or facing any source of heat, e.g. fires, radiators, boiler etc.
- Ensure the detector is positioned in place where the light source detected by the detector is consistent with actual ambient illumination. Do not locate the detector in a shadowy place.
- Where possible, mount the detector so that the logical path of an intruder would cut across the fan pattern rather than directly towards the detector (FIGURE 1).
- For best results, locate the detector directly facing an entrance.

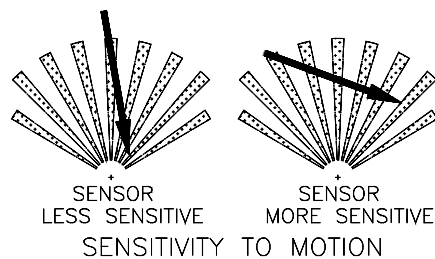

FIGURE 1

Installation

- Undo and remove the screw from the bottom edge of the detector to detach the rear cover (FIGURE 2).
- Unscrew the screw from the battery cover and remove the battery cover.
- Insert 3 AA-size 1.5V alkaline batteries to the battery compartment, ensuring correct polarity is put (FIGURE 3).

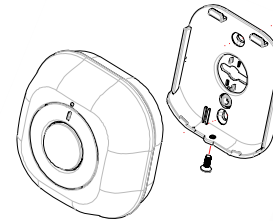

FIGURE 2

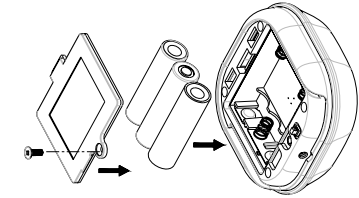

FIGURE 3

- Two ways of mounting are applicable to the detector. Decide the detector is to be wall-mounted (FIGURE 4a) or ceiling-mounted (FIGURE 5a) based on the coverage angles shown in FIGURE 4b and FIGURE 5b. Hold the rear cover in position and mark the two mounting holes. Drill the holes, insert the plastic wall plugs and screw the rear cover to the wall or ceiling using the screws provided.
- Engage the detector to the rear cover firmly.

(I) Wall Mounting

The recommended position for wall mounting is at the height of 1.8m (5.91 ft) from the floor. At this height, the optimum detection range is up to 10m (32.81 ft) with coverage range of 110 degrees (FIGURE 4b).

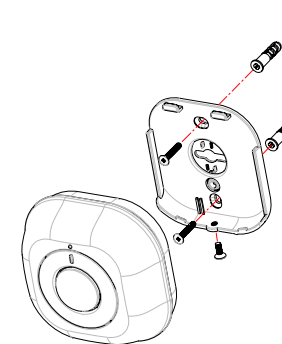

FIGURE 4a

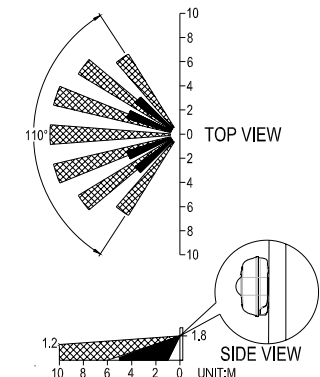

FIGURE 4b

(II) Ceiling Mounting

The recommended position for ceiling mounting is at the height of 2.8m (9.19ft) from the floor. At this height, the optimum detection range is up to 5m (16.41ft) with coverage range of 360 degrees (FIGURE 5b).

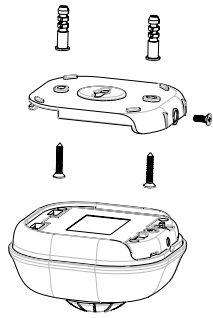

FIGURE 5a

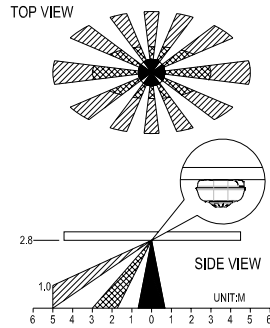

FIGURE 5b

Settings

Coverage Range Adjustments

Two types of lens covers are provided for the detector. Wall-lens cover (FIGURE 6a) is to be used when the detector is wall-mounted, whereas ceiling-lens cover (FIGURE 6b) is to be used when the detector is ceiling-mounted. The coverage range adjustment is only applicable to ceiling-lens cover; choose correct lens cover before mounting.

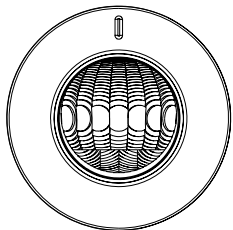

FIGURE 6a

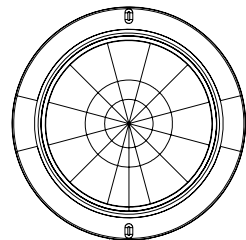

FIGURE 6b

The shading cap is composed of 12 segments for limiting the detection coverage, and each segment covers detection angle of 30 degrees (FIGURE 6c). Follow the grooves on the cap, cut the cap to a suitable size and place it onto the ceiling-lens cover (FIGURE 6d). The remaining segments are used for blanking off an undesirable detection area.

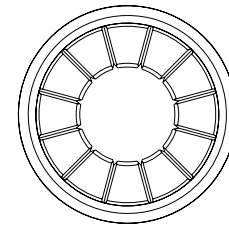

FIGURE 6c

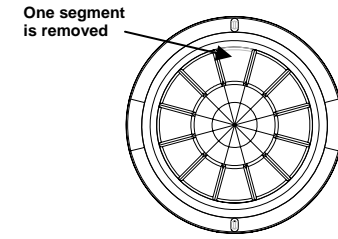

FIGURE 6d

Simply turn the cover anticlockwise to remove the wall-lens cover from the detector (FIGURE 6e).

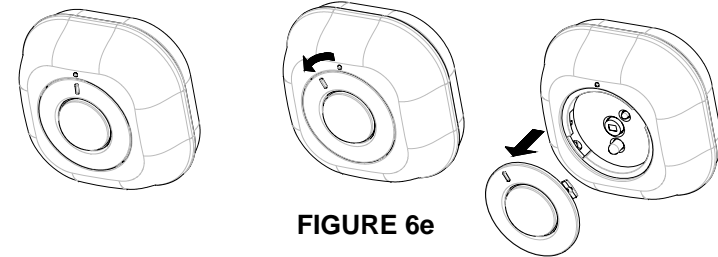

FIGURE 6e

Once the wall-lens cover is removed, reload the detector with ceiling-lens cover and turn it clockwise, ensure the mark on the cover is pointing towards and aligned with the mark on the detector (FIGURE 6f).

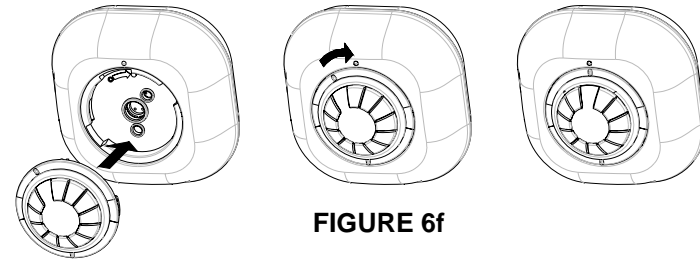

FIGURE 6f

Note: To detect movements with detection coverage up to 360 degrees, simply reload the ceiling-lens cover without shading cap. No movements can be detected if the detector is reloaded with a shading cap which maintains 12 lens segments.

Warm-Up

It will take approximately 2 minutes to warm up after battery has been connected. During this period, the detector beeps once every 3 seconds. When a long beep is sounded with red LED turns on steadily for 5 seconds, it implies warm-up procedure is completed and the detector is ready for detection.

Operation

Mounting location is a critical factor for deciding the type of lens to be used for the detector. Please decide whether the detector is going to be wall-mounted or ceiling-mounted before the operation procedure is carried on.

Wall Mounting

1. Place the wall-lens cover onto the detector.
2. By walking into a protected area within coverage of 110 degrees, the detector will now be triggered each time the detector senses movement. The orange LED on the detector will be illuminated and the associated appliances will be activated. For example, siren will be sounded or indication of movement detection will be shown on the controller. It implies that the unit is working properly.

Ceiling Mounting

1. Place the ceiling-lens cover (shading cap free) onto the detector.
2. By walking into a protected area within coverage of 360 degrees, the detector will now be triggered each time the detector senses movement. The orange LED on the detector will be illuminated and the associated appliances will be activated. For example, the siren will be sounded or indication of movement detection will be shown on the controller. It implies that the unit is working properly.
3. Place the shading cap onto the ceiling-lens cover.
4. Check whether same results can be gained by walking into a protected area within coverage that is at your disposal.

Programming

1. Z-Wave's Group (Association Command Class Version 2)

The unit supports two association groups with one node support for Grouping 1 and three nodes support for Grouping 2. This has the effect that when the unit is triggered, all devices associated with the unit will receive the relevant reports.

There are two kinds of reports: ALARM_REPORT and SENSOR_BINARY_REPORT.

1-1 Grouping 1 (Max. node = 1)

1-1-1 Power Applied Command

The unit will send ALARM_REPORT command to the nodes of Grouping 1 to inform the device that the unit is powered up.

ALARM_REPORT Command:
[Command Class Alarm, Alarm Report, Alarm Level = 0x02, Alarm Type = 0x01]

1-1-2 Intrusion Event Report (Binary Sensor Report)

Once the Detector detected a movement, the unit will send SENSOR_BINARY_REPORT to the nodes of Grouping 1 to inform there is an intrusion event. Once the movement is stopped, SENSOR_BINARY_REPORT will be sent again to the associated devices.

BINARY SENSOR REPORT Command:
Event Present:
[Command Class Sensor Binary, Sensor Binary Report, Value = 255 (0xFF)]
Event Clear:
[Command Class Sensor Binary, Sensor Binary Report, Value = 0 (0x00)]

1-1-3 Low Battery Report (Alarm Report Class)

Upon Detector status being changed, the unit will check its battery status simultaneously. When the battery level of the unit drops to an unacceptable level, the unit will flash red LED once every 30 seconds, and emit ALARM_REPORT command to the nodes of Grouping 1.

ALARM_REPORT Command:
[Command Class Alarm, Alarm Type = 0x01, Alarm Level = 255(0xFF)]

1-2 Grouping 2 (Max. node = 3)

1-2-1 Control other Z-Wave Devices

When the detector is triggered, the unit will send BASIC_SET command which contains a value that is adjustable, to the nodes of Grouping 2. For instance, the brightness level of a lamp module can be fixed according to the set value.

However, the BASIC_SET command will also be sent to the nodes of Grouping 2. For instance, a lamp module will be turned off after receiving the BAISC_SET command.

Basic Set Command: Event Present: [Command Class Basic, Basic Set, Value = 255 (0xFF)]
Event Clear: [Command Class Basic, Basic Set, Value = 0 (0x00)]

2. Z-Wave's Configuration

The following information is for someone that has some experience in setting up a Z-Wave system or someone that has computer software running a Z-Wave controller. Please get familiar with software of Z-Wave controller before getting started.

2-1 Basic Set Level

When Basic Set Command is sent where contains a value, the receiver will take it for consideration; for instance, if a lamp module is received the Basic Set command of which value is decisive as to how bright of dim level of lamp module shall be.

Example:

0: OFF
1-99: ON (Binary Switch Device)
Dim Level (Multilevel Switch Device)

Function	Parameter Number	Size	Range	Default
Basic Set level	1	1	0 ~99	99

Configuration Command

2-2 Enabling/Disabling Sensor Detecting Function

There might be times when users wish to suspend the detecting functions of the detector temporarily. By using Configuration Parameter #2, the detecting function can be set as enable or disable, where configured with the value of 0 means disable and 1 means enable.

Function	Parameter Number	Size	Value	Default
Enable/Disable Detecting	2	1	0 or 1	1

Configuration Command

Note: Reconnection of power supply will enable the sensor detecting function automatically.

2-3 Sensitivity Level (PIR sensor only)

In order to provide a best efficiency of the detector, it is recommended to test the detector with movements from a farthest end of the coverage area at first time of use. If movements cannot be detected sensitively, simply adjust the sensitivity level with Configuration Parameter #3. This parameter can be configured with the value of 1 through 10, where 1 means low sensitivity and 10 means highest sensitivity.

Function	Parameter Number	Size	Range	Default
Sensitivity Level	3	1	1~10	6

Configuration Command

2-4 Re-trigger Interval Setting (PIR sensor only)

The Configuration parameter that can be used to adjust the interval of being re-triggered after the detector has been triggered as Configuration Parameter #4. No response will be made during this interval if a movement is presented (FIGURE 7). The time interval can be set between 5 secs to 3600 secs.

Function	Parameter Number	Size	Range	Default
Re-trigger Interval	4	1 or 2 (if value > 127)	5~3600 (sec)	5

Configuration Command

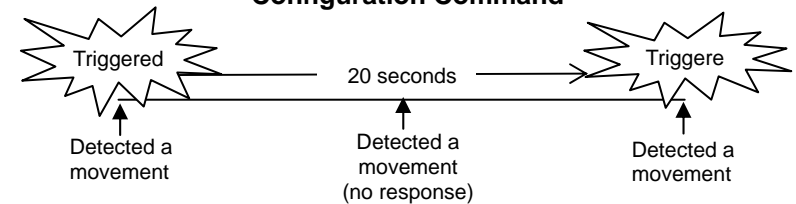

FIGURE 7

Note: The orange LED is on for one second when the detector detects a trigger.

2-5 Lux Level

The user can set a detecting percentage of lux level which determines when the light sensor will be activated. If percentage of lux level of ambient illumination falls below this percentage, and a person moves across or within

the protected area, the detector will emit Z-Wave ON Command (i.e. Basic Set Command (Value = Basic Set Level)) to controller and activate connected modules and lighting. Percentage can be set between 1% to 100%.

Function	Parameter Number	Size	Range	Default
Lux Level	5	1	1~100 %	10

Configuration Command

2-6 On-Off Duration

The function of on-off duration setting will be useful if the detector is connected with a module or lighting. The duration determines how long the module/lighting should stay ON. For instance, Lamp Module turns off 100 secs after it has been turned on. This parameter can be configured with the value of 5 through 3600, where 5 means 5 second delay and 3600 means 3600 seconds of delay.

Function	Parameter Number	Size	Range	Default
On-Off Duration	6	1 or 2 (if value > 127)	5~3600 (sec)	5

Configuration Command

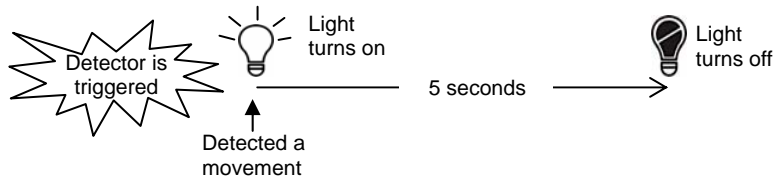

Note: The green LED will stay on for 1 second after 15 seconds of interval.

3. Advanced Programming

3-1 Battery Check Command

The users can also enquire the battery status of the Detector by sending BATTERY_GET command via Z-Wave Controller. Once the unit receives the command, it will return BATTERY_REPORT command. If the unit is in low battery status, a Battery_Level = 255 (0xFF) command will be sent to the Z-Wave Controller.

BATTERY_REPORT Command
[Command Class Battery, Battery Report, Battery Level = 20%-100%]

3-2 Wakeup Command Class

The detector stays in sleep status for the majority of time in order to conserve battery life. However, it can be woken up by either triggers of movement or by setting WAKE_UP_INTERVAL_SET command via Z-Wave Controller. After the unit wakes up, it will send Wakeup Notification Command to the node ID that requires to be reported. The minimum and maximum wakeup interval is 60 seconds and 194 days respectively. Allowable interval among each wakeup interval is 1 second, such as 60, 61, 62

Note: The default value is 1 hour, which implies that the detector awakes and sends the Wakeup Notification Command to the set node every hour.

Command Classes

The Motion Detector supports Command Classes including...

- * COMMAND_CLASS_BASIC
- * COMMAND_CLASS_BATTERY
- * COMMAND_CLASS_VERISON
- * COMMAND_CLASS_WAKE_UP_V2
- * COMMAND_CLASS_ASSOCIATION_V2
- * COMMAND_CLASS_CONFIGURATION
- * COMMAND_CLASS_SENSOR_BINARY
- * COMMAND_CLASS_MANUFACTURER_SPECIFIC

Troubleshooting

Symptom	Possible Cause	Recommendation
LED cannot be displayed	Run out of battery power	Replace a new battery
	Check if reverse battery polarity	Refit the battery with correct polarity
The detector not working	Check if mounting location is proper	Reposition its mounting location
		Remove the source of interference
	Check if the detector is out of order	Do not open the detector; send it to the local retailer.

Symptom	Possible Cause	Recommendation
Two minutes warm up is completed, but cannot hear long beep sound (LED flashes on & off repeatedly at 2-second intervals)	Check if detector is first power up or the detector has executed exclusion or reset procedure	Please carry out inclusion procedure; make sure there are ID codes stored in the detector.
The detector does not stay awake for 10 minutes	Check if detector is out of order	Please make sure link key is pressed 3 times within 1.5 sec. If detector still fails to stay awake for 10 seconds, repeat this step until it is succeeded.

Specifications

Battery	1.5V AA size x 3
Operating Range	Up to 30 meters line of sight (indoor)
Warm Up Time	About 2 minutes
PIR Detection Coverage	Wall-Mounted: Up to 10m x 110° (at 1.8m mounting height & 25°C) Ceiling-Mounted: Up to 5m x 360° (at 2.8m mounting height & 25°C)
Operating Frequency	868.42 MHz (SP814-1) / 908.42 MHz (SP814-2)
ZDK Version	V5.02

**Specifications are subject to change without notice*

A501111536R



Federal Communication Commission Interference Statement

This equipment has been tested and found to comply with the limits for a Class B digital device, pursuant to Part 15 of the FCC Rules. These limits are designed to provide reasonable protection against harmful interference in a residential installation. This equipment generates, uses and can radiate radio frequency energy and, if not installed and used in accordance with the instructions, may cause harmful interference to radio communications. However, there is no guarantee that interference will not occur in a particular installation. If this equipment does cause harmful interference to radio or television reception, which can be determined by turning the equipment off and on, the user is encouraged to try to correct the

interference by one of the following measures:

- Reorient or relocate the receiving antenna.
- Increase the separation between the equipment and receiver.
- Connect the equipment into an outlet on a circuit different from that to which the receiver is connected.
- Consult the dealer or an experienced radio/TV technician for help.

This device complies with Part 15 of the FCC Rules. Operation is subject to the following two conditions: (1) This device may not cause harmful interference, and (2) this device must accept any interference received, including interference that may cause undesired operation.

FCC Caution: Any changes or modifications not expressly approved by the party responsible for compliance could void the user's authority to operate this equipment.

This transmitter must not be co-located or operating in conjunction with any other antenna or transmitter.

WARNING:

Do not dispose of electrical appliances as unsorted municipal waste, use separate collection facilities.

Contact your local government for information regarding the collection systems available.

If electrical appliances are disposed of in landfills or dumps, hazardous substances can leak into the groundwater and get into the food chain, damaging your health and well-being.

When replacing old appliances with new once, the retailer is legally obligated to take back your old appliance for disposal at least for free of charge.