

## ZRC-90 (Scene Master) Operating Instructions



Master your home, Master your life



## Introduction

The ZRC-90 **Scene Master** (Figure 1) is a Z-Wave Central Scene Controller. When one of the buttons on the ZRC-90 is pushed, your Z-Wave central controller will receive a signal which it can use to trigger unlimited control possibilities. With 8 buttons, each supporting a long-press capability, you can control 16 different actions in your central controller. The ZRC-90 is a great solution for triggering events more quickly than taking out your smart-phone and running a home control App. The Scene Master is ideal for kids, elderly and guests who may not have full access to your smart home's mobile application and hence may not have the rights to switch on various lighting, heating, air conditioning and other home appliance. With a convenient snap-in wall mount, the ZRC-90 can also be removed to keep it handy while you go about your home for the ultimate in simple convenience.

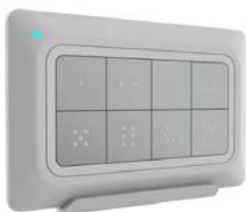

Figure 1 ZRC-90

## Gateway Requirements

Please make sure your gateway supports below functions before use ZRC-90.

Z-Wave Command Class	Controlled	Supported
Association command class	Y	N
Association Group Information (AGI) command class	Y	N
Central Scene command class	Y	Y

## Key Features

- Controls up to 8x2 pre-set scenes and 8 groups dimming function
- One learn-key setup and simple operation
- Report for key pressed 1 time, 2 times, released and held down
- Unlimited controlling capability through gateway
- Able to act as a primary or secondary controller
- Z-Wave Plus compliant
- Super thin, elegant design and able to mount to the wall-bracket

## Glossary

<b>Device or Node</b>	Devices and nodes are all terms to describe an individual Z-Wave device. These are all interchangeable when setting up your Z-Wave network.
<b>Inclusion</b>	Add a Z-Wave device to the network.
<b>Exclusion</b>	Remove a Z-Wave device from the network.
<b>Z-Wave Network</b>	A collection of Z-Wave devices controlled by primary and secondary controllers operating on the same system. A Z-Wave network has its own unique ID code so that controllers not in the network cannot control the system.
<b>Scene</b>	A collection of Z-Wave devices configured to turn to a specific level, setting, mode, or perform an operation. Scenes are usually activated by a controller, timed event, or specific conditions.
<b>Primary Controller</b>	The first controller used to set up your devices and network. Only the Primary Controller can be used to include or remove modules from a network. It is recommended that you mark the primary controller for each network for ease in modifying your network.
<b>Secondary Controller</b>	A controller containing network information about other modules within the network and is used for controlling devices. Secondary controller is created from the Primary Controller and cannot include or remove modules to the network.

<b>SUC ID Server (SIS)</b>	When a SUC is also configured as a node ID server (SIS) it enables all other controllers to include/exclude nodes. The SIS automatically becomes the Primary Controller in the network when enabled. There can only be one SIS in each individual network. To avoid inconsistency, all node ID allocations are maintained by the SIS.
<b>Inclusion Controller</b>	The SIS enables other controllers to include/exclude nodes to/from the network. When SIS functionality is enabled the controller also takes the role as the Primary Controller because it has both latest network topology and allocated node IDs. All the other controllers are called Inclusion Controllers because they can include/exclude nodes to/from the network.

## Product Overview

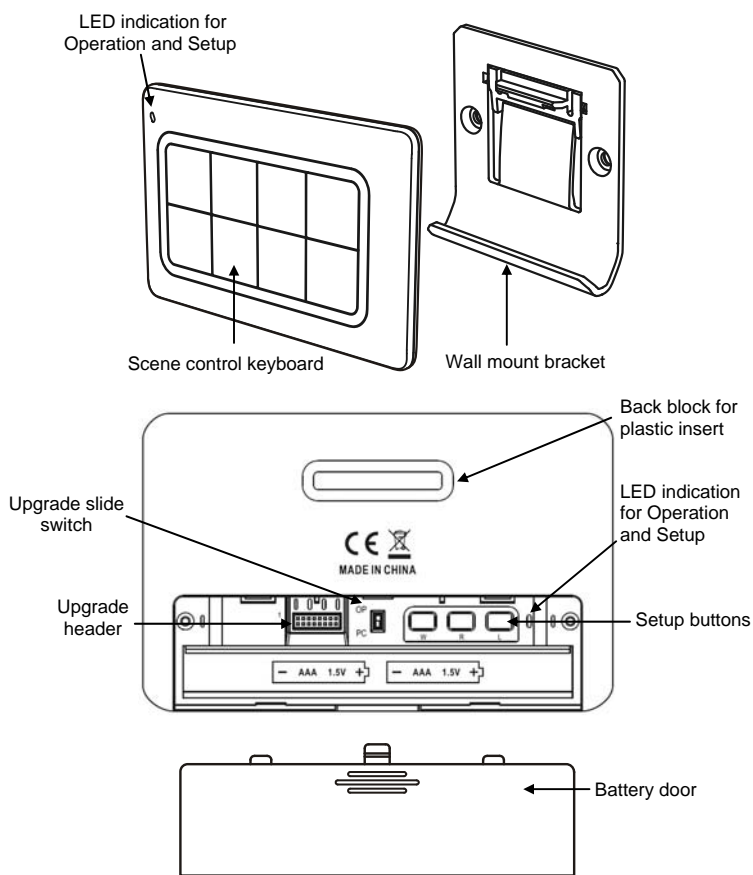
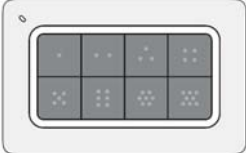









Figure 2 Setup and control keys of ZRC-90

## Description of Function Keys

Keys	Functions
	Scene control buttons
	Learn mode (Click once)
	Wake up (Click once)
	Remove device (Click once)
	Add device (Press the keys until LED light up)
	Create Primary (Press the keys until LED light up)
	Create Secondary (Press the keys until LED light up)
	Reset to factory default (Press and keep holding 10 seconds then triple click)
<p data-bbox="275 1234 311 1262">OP</p> <p data-bbox="275 1313 311 1341">PC</p> 	Slide switch OP = Normal operation ( <b>default</b> ) PC = PC firmware upgrade mode <i>(The slide switch is designed for firmware upgrade by supplier, please switch to "OP" direction for normal operation.)</i>

## Setup and Operations

Before using the ZRC-90, please install the batteries:

- 2xAAA (alkaline is recommended) batteries are required for operation.
- Remove the battery cover on the back of your remote.
- Check the polarity of the batteries and the "+/-" marks inside the battery compartment.
- Insert the batteries.
- Push the battery cover back in place.

### ⓘ CAUTION (battery safety)

- Use new batteries of the recommended type and size only.
- Never mix used and new batteries together.
- To avoid chemical leaks, remove batteries from the remote controller if you do not intend to use the remote for an extended period of time.
- Dispose of used batteries properly; do not burn or bury them.

*(Please carefully read through the following sections of this user manual and store for future reference.)*

ZRC-90 can be included and operated in any Z-Wave network with other Z-Wave certified devices from other manufacturers and/or other applications. All non-battery operated devices within the network will act as repeaters regardless of vendor to increase reliability of the network.

ZRC-90 can act as a **secondary Central Scene Controller** and trigger the pre-defined scenes through the gateway. Please follow "Add ZRC-90 into gateway network" by the procedures of "Learn mode" and "Scene activation and deactivation".

### *Z-Wave Learn mode*

ZRC-90 can also receive network information from other controllers by enter "Learn mode".

(Add / Remove ZRC-90 into / from gateway network)

Step	Setup Key	Setup LED Indication on ZRC-90
1	Refer to your primary controller instructions to process the Inclusion / Exclusion setup procedure.	-

2	<p>When prompted by your primary controller (gateway), click once on the “L” button.</p> <p>(The primary controller should indicate the action was successful. If the controller indicates the action was unsuccessful, please repeat above procedure.)</p>	LED will flash slowly until complete the step of inclusion / exclusion.
3	User can perform scene control by the keypad of ZRC-90.	<p>LED flash once then stay off if the scene operation is valid</p> <p>or</p> <p>LED flashes 6 times rapidly then stay off if the command or operation is invalid</p>

Notes:

1. If the device already existed into the network, the unit will exit Learn mode automatically after 5 seconds.
2. If the device does not exist into the network and no command from gateway, the unit will exit Learn mode automatically after 30 seconds.

### *Scene activation and deactivation*

The real actions of scene will be depended on each gateway interpretation.

<b>ZRC-90 key action</b>	<b>Gateway interpretation example</b>
Key pressed 1 time (within 1 seconds )	Scene activation
Key released	-
Key held down (press and keep holding more than 2 seconds)	Dimming up/down for a group device
Key pressed 2 times (within 1 seconds)	Scene deactivation



Notes:

1. Association Group-1 will be a default status report channel in Z-Wave+ lifeline requirement. Only one node can be assigned to this association group.

## *Z-Wave Wakeup (Listening mode)*

There are multiple usages by entering this mode:

- Version information: To get application software version, the Z-Wave protocol version and the supported Z-Wave command version of this controller.
- Manufacturer Specific information: To get the manufacture ID, product type ID and the product ID of this controller.
- Association configuration: To create and maintain associations to ZRC-90.

Step	Setup Key	Setup LED Indication on ZRC-90
1	Enter to the Listening mode by click once on "W" button.	LED will keep flashes slowly
2	Listening mode will exit automatically after 30 seconds of inactivity.	LED stay off

Notes:

1. The mode must not be exited during communication process with another controller. Please wait for entire communication process to be completed.
2. It is not allowed to enter any user input from the remote's hard key after entry this mode.

**ZRC-90 act as a primary controller.** It can perform Add/Remove device to/from a network and create a primary/secondary controller. Please reset ZRC-90 to factory default to act as a primary controller if need perform Add or Remove function.

## *Add/Remove Devices*

### Adding Device to the Network

Step	Setup Key	Setup LED Indication on ZRC-90
1	Press "L+R" buttons simultaneously until LED light up to add the device	LED will keep flashes slowly

	into ZRC-90 Z-Wave network.	
2	Press the program button on the target device.	LED flash once then stay off if the device is included into the network  or LED flashes 6 times rapidly then stay off if the operation is invalid

Notes:

1. If you can't add your Z-Wave device, this device might have been included in another Z-Wave network. In this case, please remove this device following the steps in the [Removing Device from the Network] section then add this device again.
2. This step can be skipped if the device is already included in the network.
3. In a Z-Wave network, only the primary controller or inclusion controller can add or include devices into its network. If ZRC-90 is configured as a secondary controller, it will report "Error" if users attempt to use ZRC-90 to add a device into its network.
4. If no ACK signal received for more than 30 seconds, the "Add Device" mode will exit automatically.

Removing Device from the Network

Step	Setup Key	Setup LED Indication on ZRC-90
1	Click once on the "R" button to remove the device from ZRC-90 Z-Wave network.	LED will keep flashes slowly
2	Press the program button on the target device.	LED flash once then stay off if the device is excluded from the network  or LED flashes 6 times rapidly then stay off if the operation is invalid

Notes:

1. In a Z-Wave network, only the primary controller or inclusion controller can remove or exclude devices from its network. If ZRC-90 is configured as a secondary controller, it will report "Error" if users attempt to use ZRC-90 to remove a device from its network.
2. If no ACK signal received for more than 30 seconds, the "Remove Device" mode will exit automatically.

## Create a Primary Controller

(Transferring Only Network Information to a New Primary Controller)

You can just transfer network information to another controller so that it will act as a new primary controller and ZRC-90 will act as a secondary controller. This primary shift is done by following the steps below.

Step	Setup Key	Setup LED Indication on ZRC-90
1	Place the two controllers close to each other.	-
2	Press "W+L" buttons simultaneously until LED light up.	LED will keep flashes slowly
3	<p>Please make sure the target primary controller is setup to receive information mode. (e.g. target primary controller should enter the "Learn mode" if this is a another ZRC-90. Please refer to the target controller user manual for more information)</p> <p>=&gt; Target primary controller will act as a <u>primary</u> controller after this action.</p> <p>=&gt; Original ZRC-90 primary controller will act as a <u>secondary</u> controller after this action.</p>	LED will flashes slowly until complete the step of "Create a Primary Controller"

## Create a Secondary Controller

(Copying Network Information to a Secondary Controller)

You can add a secondary controller to your network and copy all of ZRC-90 primary controller's network information to the secondary controller by following the steps below.

Step	Setup Key	Setup LED Indication on ZRC-90
1	Place the two controllers close to each other.	-
2	Press "W+R" buttons simultaneously until LED light up.	LED will keep flashes slowly
3	<p>Please make sure the target secondary controller is setup to receive information mode. (e.g. target secondary controller should enter the "Learn mode" if this is a another ZRC-90. Please refer to the target controller user manual for more information)</p> <p>=&gt; Target secondary controller will act as a <u>secondary</u> controller after this action.</p> <p>=&gt; Original ZRC-90 primary controller will still keep in a <u>primary</u> controller after this action.</p>	LED will flashes slowly until complete the step of "Create a Secondary Controller"

## Reset to factory default

ZRC-90 will be excluded from network and restored to factory default setting.

Step	Setup Key	Setup LED Indication on ZRC-90
1	Press and keep holding "R" button not less than 10 seconds.	LED will light up at first 5seconds. LED will turn off after 10seconds.
2	Release "R" button then triple click on "R" button within 2 seconds.	LED flashes twice then stay off after reset process completed.

## *Battery low indication*

The unit will detect battery status after key pressed, the LED will flashes 3 times rapidly then stay off when battery low is detected. Meanwhile, it will report battery low status to gateway automatically.

## **Physical Installation**

In case you need to mount the ZRC-90 into the wall bracket, please be sure to fully read the following precautions and procedures.

### MOUNTING LOCATION PRECAUTIONS

- Before mounting, check the material and structure of the mounting location. If the location does not have the proper material or structure, the unit can fall and cause injuries.
- Use commercial items that best match the wall structure and material for the screws and other fixtures.
- Do not mount near a kitchen counter, humidifier, or other location in which it can be exposed to smoke or steam. Doing so could cause a fire or electrical shock.
- Do not mount in locations with high humidity or large amounts of dust. Doing so could cause a fire or electrical shock.
- Do not mount to locations subject to high temperatures, high humidity, or exposure to water. Doing so could cause a fire or electrical shock.
- Do not mount to locations subject to large amounts of vibration, large jolts, or large forces. These could cause an injury if the unit falls and breaks.

### MOUNTING PROCEDURE PRECAUTIONS

- Do not modify parts or use the unit in ways other than its intended use. Doing so could cause the unit to fall and result in an injury.
- Be sure to fully check that there are no electrical wires or pipes inside the wall before mounting.
- If any of the screws are loose, the unit can fall and cause an injury. Do not mount the unit with the screws still loose.
- Check that the two screws mounted to the wall are fully inserted into the key holes of the unit. Otherwise, the unit can fall and cause an injury.
- Do not mount the unit so that it sticks out from the wall edge. It could get hit by people's bodies or objects and cause an injury.
- Supplier will not be liable for any accidents or injuries that occur due to improper mounting or handling.
- When mounting, be careful not to get your fingers pinched or injure your hands.

## MOUNTING PROCEDURE

The ZRC-90 can be mounted to a wall or wooden racks using the two key holes in the wall bracket.

Notes:

1. The RF reception sensitivity and transmit power are varies depending on the antenna direction.
2. Before mounting to a wall, be sure to fully read the precautions.

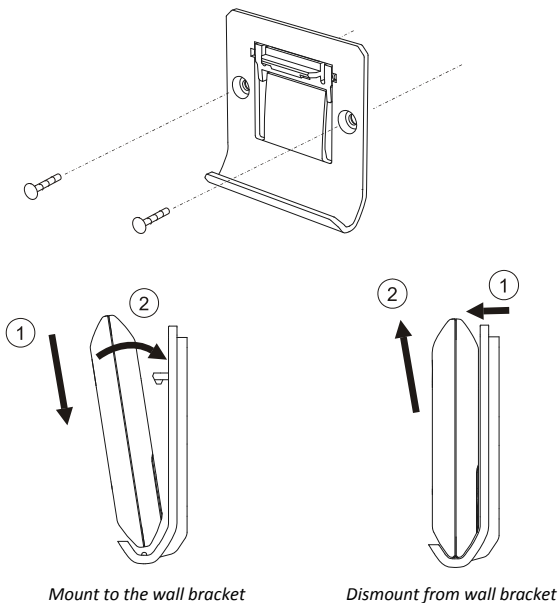

Figure 3 Installation

## Technical Specifications

<b>Model no.</b>	BW8510US (ZRC-90US) BW8510EU (ZRC-90EU) BW8510AU (ZRC-90AU) BW8510RU (ZRC-90RU) BW8510IN (ZRC-90IN) BW8510IL (ZRC-90IL) BW8510JP (ZRC-90JP)
<b>RF frequency</b>	908.42MHz (ZRC-90US) 868.42MHz (ZRC-90EU) 921.42MHz (ZRC-90AU) 869.02MHz (ZRC-90RU)

	865.22MHz (ZRC-90IN) 916.02MHz (ZRC-90IL) 922.50MHz (ZRC-90JP)
<b>LED indication</b>	Blue
<b>RF operating distance</b>	up to 132ft (40m) outdoor line of sight, in unobstructed environment
<b>Powered by</b>	Dry battery AAA x 2pcs
<b>Temperature</b>	Operation: 0 to 40°C Storage: -20 to 60°C
<b>Humidity</b>	20 to 85%, non-condensing
<b>Dimension</b>	110mm x 70mm x 13.5mm
<b>Weight</b>	60g (main unit and batteries excluded) 15g (wall mount bracket)

## Checking Accessories

After opening the cover of the packing box, check that the following accessories are included.

- ZRC-90 Scene Master
- Plastic insert
- Wall mount bracket
- Wall anchor x 2pcs
- Screw x 2pcs
- User Manual
- Warranty sheet
- Scene label sheet

## Scene Reference List

Scene Button	Action in single click	Action in double click	Remark
1			
2			
3			
4			
5			
6			
7			
8			

*(Please write down the scene action in case you need further reference in the future.)*

## Wireless Information

This device has an open-air line-of-sight transmission distance of 132 feet (40m) which complies with the Z-Wave standards. Performance can vary depending on the amount of objects in between Z-Wave devices such as walls and furniture. Every Z-Wave device set up in your network will act as a signal repeater allowing devices to talk to each other and find alternate routes in the case of a reception dead spot.

Radio frequency limitations:

1. Each wall or object (i.e.: refrigerator, bookshelf, large TV, etc) can reduce the maximum range of 65 feet (20m) by up to 20 to 30%.
2. Plasterboard and wooden walls block less of the radio signal than concrete, brick or tile walls which will have more of an effect on signal strength.
3. Wall mounted Z-Wave devices will also suffer a loss of range if they are housed in metal junction boxes which could also reduce the range by up to 20 to 30%.

## Maintenance

1. Do not expose your unit to dust, strong sunlight, humidity, high temperatures or mechanical shocks.
2. Do not use old and new batteries together as old batteries tend to leak.
3. Do not use corrosive or abrasive cleansers on your unit.
4. Keep the unit dust free by wiping it with a soft, dry cloth.
5. Do not disassemble the unit, it contains no user-serviceable parts.

## FCC Notice

This device complies with Part 15 of the FCC rules. Operation is subject to the following two conditions:

- (1) this device may not cause harmful interference, and
- (2) this device must accept any interference received, including interference that may cause undesired operation.

Note: This equipment has been tested and found to comply with the limits for a Class B digital device, pursuant to Part 15 of the FCC Rules. These limits are designed to provide reasonable protection against harmful interference in a residential installation. This equipment generates, uses and can radiate radio frequency energy and, if not installed and used in accordance with the instructions, may cause harmful interference to radio communications. However, there is no guarantee that interference will not occur in a particular installation. If this equipment does cause harmful interference to radio or television reception, which can be determined by turning the equipment off and on, the user is encouraged to try to correct the interference by one or more of the following measures:



- Reorient or relocate the receiving antenna.
- Increase the separation between the equipment and receiver.
- Connect the equipment into an outlet on a circuit different from that to which the receiver is connected.
- Consult the dealer or an experienced radio/TV technician for help.

Notice: Changes or modifications to this unit not expressly approved by the party responsible for compliance could void the user authority to operate the equipment.

## **Warnings**

- Do not modify the unit in any way.
- Risk of fire.
- Risk of electrical shock.
- Risk of burns.
- Do not dispose of electrical appliances and unsorted municipal waste, use separate collection facilities. Contact your local government for information regarding the collection systems available.
- There is no user serviceable parts in this unit.
- Use only power supplies listed in the user instructions.

## **Caution**

- Risk of explosion if battery is replaced by an incorrect type.
- Dispose of used batteries according to the instructions.