

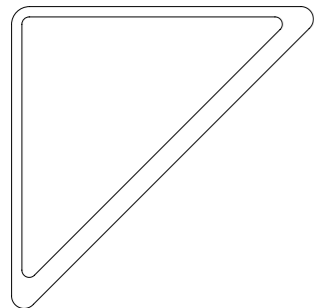

DOOR / WINDOW SENSOR 6

View the expanded manual:
<http://aeotec.com/support>



① Aeotec by Aeon Labs Door Window Sensor.

The Aeotec by Aeon Labs Door/Window Sensor 6 provides your Z-Wave network with the security intelligence required for a modern home automation and security system. And It does it all in a smaller, more elegant design crafted to suit any home's decor.

The Door Window Sensor is also a security Z-wave device that supports Over The Air (OTA) for firmware updates.

② Familiarize yourself with your Door Window Sensor.

Package contents:

1. Sensor Unit.
2. Back Mounting Plate.
3. Magnet Unit (x2).
4. Double-Sided Tape(x2).
5. Screws (x3).
6. USB cable.

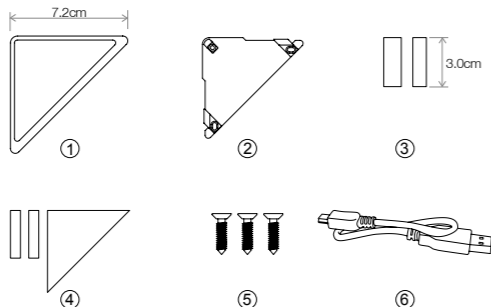
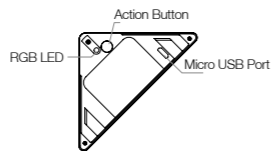

③ Quick start.

Installing your Door Window Sensor.

The installation of your Door Window Sensor has two major steps: the Main Sensor and the Magnet. Your Door Window Sensor will use wireless technology to talk to your Z-Wave network once paired to your Z-Wave network.

Selecting where you'll place your Door/Window Sensor in your home is just as important as the actual affixing it to the surface.

Whether it's for security or intelligence purposes, your sensor:

1. Should be affixed indoors and away from sources of moisture.
2. Placed within 30 meters of another Z-Wave device that is either a gateway or not powered by batteries.
3. The magnet and the main sensor must be less than 1.6cm apart for the small magnet installation or 2.5cm apart for the big magnet installation. Main sensor must be affixed to the door or window and the magnet must be affixed to the frame. The magnet and the main sensor must separate when the door or window is opened.
4. Should not be mounted on a metal frame.

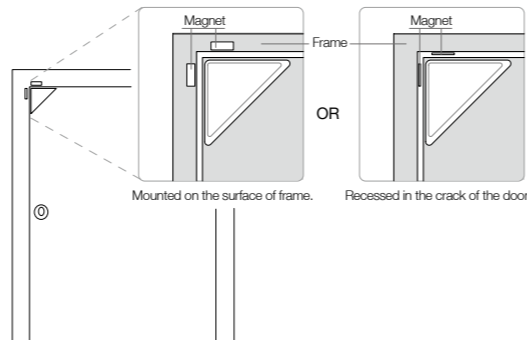

Affix your Back Mounting Plate and Magnet to a surface. The Back Mounting Plate can be affixed using screws or double-sided tape and should be mounted on the apex angle of the door. The Magnet must be affixed using double-sided tape and can't exceed the valid range, see the figure below.

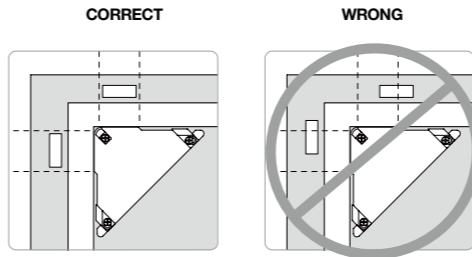

- Note:
1. There are 2 types of Magnets (Magnet 1: 30mmx6mmx2mm, Magnet 2: 30mmx10mmx2mm), the size of magnet 2 is a little larger than magnet 1.
 2. You can choose to install each one of magnet on the door frame according to your need or the distance between the door and frame, see the figure below.

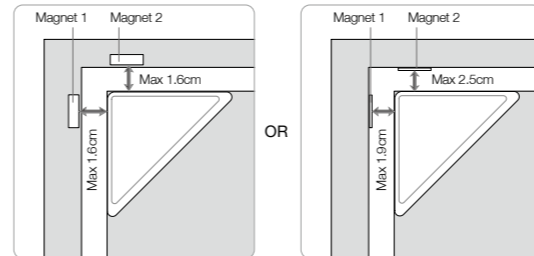

3. Keep Magnets away from children to avoid swallowing.

When the Back Mounting Plate is affixed by the double-sided tape, wipe the two surfaces clean of any oil or dust with a damp towel. When the surface has completely dried, peel one side of the tape back and attach it to the corresponding section on the rear side of the Back Mounting Plate.

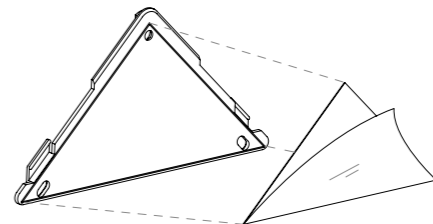

Adding your Sensor to your Z-Wave network.

With your mounting plates prepared to hold each component of your sensor, it's time to add it to your Z-Wave network.

1. Let your Z-Wave primary controller/gateway enter into adding/inclusion mode.
2. Take your Sensor near to your primary controller.
3. Press the Action Button once on your Sensor. The green LED will blink.
4. If your Door Window Sensor has been successfully added to your Z-Wave network, its green LED will be solid for 2 seconds and then the orange LED will fast blink for 10 minutes if the Sensor does not receive the Wake Up No More info Command from Controller. If the adding was unsuccessful and the red LED will be solid for 2 seconds and then off, repeat the above steps.

With your Sensor now working as a part of your smart home, you'll be able to configure it from your home control software or phone application. Please refer to your software's user guide for precise instructions on configuring the Door Window Sensor to your needs.

Attach your Sensor to its Back Mounting plate.

With your Sensor added to the Z-Wave network. It's now time to insert the main unit into the corresponding sensor plate. Put the main unit in the top-left direction on the Back Mounting, and then push the Sensor into the Back Mounting Plate, as the figure below shows.

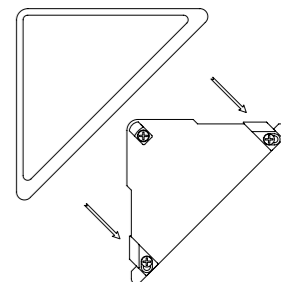

After the installation is complete, you can also paint on the Door Window Sensor to match with the door colour and let them look like a whole unit.

④ Advanced functions.

Send a wake up notification.

In order to send your Sensor new configuration commands from your Z-Wave controller or gateway, it will need to be woken up.

1. Remove your Sensor unit from its Back Mounting Plate, press the Action Button on the back of the Sensor unit and then release the Action Button. This will trigger and send a wake up notification command to your controller/gateway.
2. If you want your Sensor to keep awake for a longer time, press and hold the Action Button on the back of the Sensor unit for 3 seconds, then your Sensor will wake up for 10 minutes and the orange LED will fast blink while it is awake.

Removing your Sensor from your Z-Wave network.

Your sensor can be removed from your Z-Wave network at any time. You'll need to use your Z-Wave network's main controller/gateway. To do this, please refer to the part of their respective manuals that tell you how to remove devices from your network.

1. Put your primary controller into device removal mode.
2. Unlock your Sensor from the Back Mount plate and take the Sensor unit near to your primary controller.
3. Press the Action Button on your Sensor.
4. If your Door Window Sensor is successfully removed from the Z-Wave network, the RGB LED will become a colourful gradient for a few seconds and then turn off. If the removing was unsuccessful, the RGB LED will be solid for 8 seconds and then turn off, repeat the above steps.

Security or Non-security feature of your Sensor in Z-wave network.**Including Door Window Sensor as a non-secure device:**

If you want your Sensor as a non-security device in your Z-wave network, you just need to press the Action Button once on Door Window Sensor when you use a controller/gateway to add/include your Sensor. The green LED will be on for 2 seconds and then the orange LED will fast blink for 10 minutes (if the Sensor does not receive the Wake Up No More Info command from primary Controller) to indicate the inclusion is successful.

Including Door Window Sensor as a secure device:

In order to take full advantage of all functionality the Door Window Sensor, you may want your Sensor is a security device that uses secure/encrypted message to communicate in Z-wave network, so a security enabled controller/gateway is needed for the Door Window Sensor to be used as a security device. You need to press the Sensor's Action Button 2 times within 1 second when your security controller/gateway starts the network inclusion. The blue LED will be on for 2 seconds and then the orange LED will fast blink for 10 minutes (if the Sensor does not receive the Wake Up No More Info command from primary Controller) to indicate the inclusion is successful.

Factory Reset your Sensor.

If your primary controller is missing or inoperable, you may wish to reset all of your Door Window Sensor's settings to their factory defaults. To do this, press and hold the Action Button for 20 seconds and the green LED will be solid for 2 seconds and then be colourful gradient to confirm a success.

Your Sensor's battery.

Your Door Window Sensor has a internal rechargeable lithium battery that will last for 6 months on a full charge when it is in normal use condition. The charger's output should be a micro USB terminal with the specification of output DC 5V/1A. When the Door Window Sensor is in charge state, the orange LED will be on. If the orange LED is off and the green LED remains on, then it indicates that the battery charge is complete.

⑤ Technical specifications.

Model number: ZW112.

Power supply: Rechargeable Lithium battery, 3.7 V, 500mAh.

Battery charger input: Micro USB port, DC 5V±0.5V, max 1A.

Operating temperature: 0°C to 40°C/32°F to 104°F.

Relative humidity: 8% to 80%.

Water proofing: IP20 (Indoor use only).

Operating distance: Up to 492 feet/150 metres outdoors.

⑥ Warranty.

If you are in need of any technical support during or subsequent to your products' warranty, please get in touch with our support team via <http://aeotec.com/support>. The Company you bought this product from has also guaranteed to assist you with any of your support needs, and you can also contact them for accordingly.

This guarantee made by the company who you purchased the product from includes the transfer of Aeon Labs' full warranty to that Company. They've guaranteed that they'll be able to assist you, the Customer, with all technical support and repair needs on our behalf.

Aeon Labs warrants to the original purchaser of Products, that is the Company

who you have purchased from, that for the Warranty Period (as defined below), the Products will be free from material defects in materials and workmanship. The foregoing warranty is subject to the proper installation, operation and maintenance of the Products in accordance with installation instructions and the operating manual supplied. Warranty claims must be made to the Company who you have purchased from in writing within thirty (30) days of the manifestation of a problem.

Aeon Labs' sole obligation under the foregoing warranty is, at Aeon Labs' option, to repair, replace or correct any such defect that was present at the time of delivery, or to remove the Products and to refund the purchase price to Company.

The Warranty Period begins on the date the Products is delivered and continues for 12 months. Any repairs under this warranty must be conducted by an authorized Aeon Labs service representative and under Aeon Labs' RMA policy. Any repairs conducted by unauthorized persons shall void this warranty.

Excluded from the warranty are problems due to accidents, acts of God, civil or military authority, civil disturbance, war, strikes, fires, other catastrophes, misuse, misapplication, storage damage, negligence, electrical power problems, or modification to the Products or its components.

Aeon Labs does not authorize any person or party to assume or create for it any other obligation or liability in connection with the Products except as set forth herein. Aeon Labs will pass on to Company all manufacturers' Material warranties to the extent that they are transferable, but will not independently warrant any Material. Company will assist Customer with all warranty, repair, return and technical support needs, Company must prepay shipping and transportation charges for returned Products, and insure the shipment or accept the risk of loss or damage during such shipment and transportation. Aeon Labs will ship the repaired or replacement products to Company freight prepaid. Customer and Company shall indemnify, defend, and hold Aeon Labs and Aeon Labs' affiliates, shareholders, directors, officers, employees, contractors, agents and other representatives harmless from all demands, claims, actions, causes of action, proceedings, suits, assessments, losses, damages, liabilities, settlements, judgments, fines, penalties, interest, costs and expenses (including fees and disbursements of counsel) of every kind (i) based upon personal injury or death or injury to property to the extent any of the foregoing is proximately caused either by a defective product (including strict liability in tort) or by the negligent or willful acts or omissions of Customer or its officers, employees, subcontractors or agents, and/or (ii) arising from or relating to any actual or alleged infringement or misappropriation of any patent, trademark, mask work, copyright, trade secret or

any actual or alleged violation of any other intellectual property rights arising from or in connection with the products, except to the extent that such infringement exists as a result of Aeon Labs' manufacturing processes.

IN NO EVENT SHALL AEON LABS BE LIABLE FOR ANY INDIRECT, INCIDENTAL, PUNITIVE, SPECIAL OR CONSEQUENTIAL DAMAGES, OR DAMAGES FOR LOSS OF PROFITS, REVENUE, OR USE INCURRED BYCUSTOMER, COMPANY OR ANY THIRD PARTY, WHETHER IN AN ACTION IN CONTRACT, OR TORT, OR OTHERWISE EVENIF ADVISED OF THE POSSIBILITY OF SUCH DAMAGES. AEON LABS' LIABILITY AND CUSTOMER'S EXCLUSIVE REMEDY FOR ANY CAUSE OF ACTION ARISING IN CONNECTION WITH THIS AGREEMENT OR THE SALE OR USE OF THE PRODUCTS, WHETHER BASED ON NEGLIGENCE, STRICT LIABILITY, BREACH OF WARRANTY, BREACH OF AGREEMENT, OR EQUITABLE PRINCIPLES, IS EXPRESSLY LIMITED TO, AT AEON LABS' OPTION, REPLACEMENT OF, OR REPAYMENT OF THE PURCHASE PRICE FOR THAT PORTION OF PRODUCTS WITHRESPECT TO WHICH DAMAGES ARE CLAIMED. ALL CLAIMS OF ANY KIND ARISING IN CONNECTION WITH THIS AGREEMENT OR THE SALE OR USE OF PRODUCTS SHALL BE DEEMED WAIVED UNLESS MADE IN WRITING WITHIN THIRTY (30) DAYS FROM AEON LABS' DELIVERY, OR THE DATE FIXED FOR DELIVERY IN THE EVENT OF NONDELIVERY. THE INDEMNITY AND WARRANTY IN ABOVE ARE EXCLUSIVE AND IN LIEU OF ALL OTHER INDEMNITIES OR WARRANTIES, WHETHER EXPRESS OR IMPLIED, INCLUDING THE IMPLIED WARRANTIES OF MERCHANTABILITY AND FITNESS FOR A PARTICULAR PURPOSE.

FCC NOTICE (for USA)

THE MANUFACTURER IS NOT RESPONSIBLE FOR ANY RADIO OR TV INTERFERENCE CAUSED BY UNAUTHORIZED MODIFICATIONS TO THIS EQUIPMENT.SUCH MODIFICATIONS COULD VOID THE USER'S AUTHORITY TO OPERATE THE EQUIPMENT.

STORE INDOORS WHEN NOT IN USE. SUITABLE FOR DRY LOCATIONS. DO NOT IMMERSE IN WATER. NOT FOR USE WHERE DIRECTLY EXPOSED TO WATER.

This device complies with Part 15 of the FCC Rules. Operation is subject to the following two conditions:

1. This device may not cause harmful interference, and
2. This device must accept any interference received, including interference that may cause undesired operation. This equipment has been tested and found to comply with the limits for a Class B digital device, pursuant to part 15 of the FCC Rules. These limits are designed to provide reasonable protection against harmful interference in a residential installation. This equipment generates,

uses and can radiate radio frequency energy and, if not installed and used in accordance with the instructions, may cause harmful interference to radio communications. However, there is no guarantee that interference will not occur in a particular installation. If this equipment does cause harmful interference to radio or television reception, which can be determined by turning the equipment off and on, the user is encouraged to try to correct the interference by one or more of the following measures:

- Reorient or relocate the receiving antenna.
- Increase the separation between the equipment and receiver.
- Connect the equipment into an outlet on a circuit different from that to which the receiver is connected.
- Consult the dealer or an experienced radio/TV technician for help.

Warning

Do not dispose of electrical appliances as unsorted municipal waste, use separate collection facilities.

Contact your local government for information regarding the collection systems available.

Certifications (regional):

Z-Wave and Z-Wave Plus are registered trademarks of Sigma Designs and its subsidiaries in the United States and other countries

FCC ID: XBAFT112



AEOTEC
BY AEON LABS

Association information

5.3 Association Command Class

The Door Window Sensor supports 1 association group and can add Max 5 nodes in group 1.

Association Group	Nodes	Send Mode	Send commands
Group 1	0	N/A	N/A
	[1,5]	Single Cast	Send Sensor Binary Report (configurable in parameter 121) or Basic Set Command (configurable in parameter 121) or Notification Report Command when the Sensor is triggered.

5.4 Association Group Info Command Class

5.4.1 Association Group Info Report Command Class

Profile: General: NA (Profile MSB=0, Profile LSB=0)

5.4.2 Association Group Name Report Command Class

Group 1: Lifeline

Configuration parameters information

Parameter Number Hex / Decimal	Description	Default Value	Size
0x01 (1)	Which value of the Sensor Binary Report or Basic Set will be sent when the Magnet is triggered On/Off. 1, Value=0, On=Sensor Binary Report/Basic Set 0xFF, Off=Sensor Binary Report/Basic Set 0x00. 2, Value=1, On= Sensor Binary Report/Basic Set 0x00, Off= Sensor Binary Report/Basic Set 0xFF.	0	1
0x27 (39)	Set the low battery value. (10% to 50%)	20	1
0x65 (101)	Enable/disable the function of parameter 0x6F. (0=disable, 1=enable) <i>Note:</i> this parameter cannot disable the low battery checking of the Sensor itself.	1	1
0x6F (111)	Set the interval time of low battery checking. The minimum interval is 4 minutes. Its range is 0 to 0x7FFFFFFF.	0x00015270	4
0x79 (121)	To configure which sensor report will be sent when the Magnet is triggered On/Off. Value=0, send nothing. Value=1, send Basic Set CC. Value=2, send Sensor Binary Report CC. Value=3, send Basic Set CC and Sensor Binary CC.	1	1
0xFC (252)	Lock/unlock all configuration parameters. (0=unlock, 1=lock)	0	1
0xFF (255)	1, Value=0x55555555, Default=1, Size=4 Reset to factory default setting and removed from the z-wave network	N/A	4
	2, Value=0, Default=1, Size=1 Reset to factory default setting	N/A	1